

LA-8206

c. 3

CIC-14 REPORT COLLECTION

**REPRODUCTION  
COPY**

**Three-Dimensional Eulerian Calculations of  
Triple-Initiated PBX 9404**

University of California



**LOS ALAMOS SCIENTIFIC LABORATORY**

Post Office Box 1663 Los Alamos New Mexico 87545

Edited by Sharon L. Crane  
Photocomposition by Chris West

**DISCLAIMER**

This report was prepared as an account of work sponsored by an agency of the United States Government. Neither the United States Government nor any agency thereof, nor any of their employees, makes any warranty, express or implied, or assumes any legal liability or responsibility for the accuracy, completeness, or usefulness of any information, apparatus, product, or process disclosed, or represents that its use would not infringe privately owned rights. Reference herein to any specific commercial product, process, or service by trade name, trademark, manufacturer, or otherwise, does not necessarily constitute or imply its endorsement, recommendation, or favoring by the United States Government or any agency thereof. The views and opinions of authors expressed herein do not necessarily state or reflect those of the United States Government or any agency thereof.

**UNITED STATES  
DEPARTMENT OF ENERGY  
CONTRACT W-7405-ENG. 36**

LA-8206

UC-34

Issued: September 1980

# Three-Dimensional Eulerian Calculations of Triple-Initiated PBX 9404

Charles L. Mader  
James D. Kershner



# THREE-DIMENSIONAL EULERIAN CALCULATIONS OF TRIPLE-INITIATED PBX 9404

by

Charles L. Mader and James D. Kershner

## ABSTRACT

The three-dimensional, reactive, Eulerian hydrodynamic code, 3DE, is described and used to model numerically the interaction of three spherically diverging detonation waves. The shock initiation burn model called Forest Fire was used to model the explosive decomposition. The formation of regular and Mach shock reflections, which result from the interaction of three detonation waves, is described.

## I. INTRODUCTION

The Eulerian equations of motion are effective for numerical solution of highly distorted flow. The two-dimensional, reactive, Eulerian computer code, 2DE, is described in detail in Ref. 1. The unique features of the technique used in 2DE are the mixed equation-of-state treatments and the use of the associated mixed-cell state values in the mass movement across cell boundaries. These permit solution of interface flow within the cell resolution and state values almost as accurate as one can obtain with Lagrangian treatments. Keeping track of the mixed-cell properties and rather complicated logic is required to follow the mass movement.

The first three-dimensional Eulerian hydrodynamic code used the particle-in-cell technique. It was described by Gage and Mader<sup>2</sup> in 1966, when it was used to study the closure of a cubical hole in nitromethane by a shock wave propagating up one side of the cube. The calculation described the resulting three-dimensional hydrodynamic hot spot. The first three-dimensional continuous Eulerian code was described by Johnson<sup>3</sup> in 1967. A three-dimensional incompressible calculation was used to study flow around buildings by Hirt and

Cook<sup>4</sup> in 1972. Compressible three-dimensional calculations of blast loading and channel flow are described in Refs. 5-7. Wilkins<sup>8</sup> developed the first three-dimensional Lagrangian hydrodynamic code in 1970. Although there have been various three-dimensional hydrodynamic codes for over a decade, they have been little used because most problems required more resolution than could be obtained with the available computer hardware.

The new CRAY computer, with its million words of memory, permits approximately 64 000 cells or a cube with 40 cells on each side. Although this is inadequate for most problems, it permits study of some problems in reactive fluid dynamics.

We have constructed a three-dimensional, reactive, multicomponent Eulerian hydrodynamic code called 3DE. The 3DE code uses techniques identical to those in 2DE for describing mixed cells and multicomponent equations of state and for modeling reactive flow. The code is described in the appendix.

## II. CALCULATION OF TRIPLE-INITIATED PBX 9404

Recent radiographic and numerical studies<sup>9</sup> of two laterally colliding, diverging, cylindrical detonations in

PBX 9404 examined the formation of regular and Mach shock reflections of colliding detonations in two dimensions. The experimentally observed flow was reproduced using two-dimensional hydrodynamics with a shock-initiation burn model called Forest Fire<sup>1</sup> to describe the explosive burn. The HOM<sup>1</sup> equation-of-state constants and Forest Fire constants for PBX 9404 used in the 2D and 3D calculations are given in Chapter 4 of Ref. 1. This study objective was to examine the formation of regular and Mach shock reflections from three colliding, spherically diverging detonations and, in particular, the triple-shock reflection, which was expected from the interaction of three detonation waves.

The geometry studied is shown in Fig. 1. Three detonator cubes of 4 by 4 by 4 cells are placed either symmetrically or unsymmetrically in a cube of PBX 9404 with air on its bottom side and continuum boundaries on its other sides. The indices *i*, *j*, and *k* designate the position on the *x*-, *y*-, and *z*-coordinates. The air thickness is *k* of 2. An undecomposed explosive layer of one cell thickness is between the air and the bottom of the hot spots. The total cube height is *k* of 18. The symmetric detonator problem had an *i* of 18 and *j* of 17, as shown in Fig. 2. The nonsymmetric detonator problem had an *i* of 21 and *j* of 16, as shown in Fig. 3. The detonator cubes were initially decomposed PBX 9404 with a 3.0-g/cm<sup>3</sup> initial density and a 0.05-Mbar-cm<sup>3</sup>/g energy. To initiate prompt propagating, diverging detonation, the initial detonator conditions must suffice to shock the surrounding undecomposed PBX 9404 to several hundred kilobars. The computational cell size used was 0.2 cm, and the time step was 0.025 μs. The computer time on the CDC 7600 computer was about 6 minutes for 125 cycles.

The expected wave interactions are sketched for the symmetric detonator case in Fig. 2 and the nonsymmetric case in Fig. 3. The sketches show the expected three spherically diverging waves interacting as pairs and as triplets. The dashed lines show the waves just after double-wave interaction has occurred, and the dark regions show the areas of double-wave interaction. The solid lines and dotted regions show the waves after triple-wave interaction has occurred.

Considerable effort is required to envision a three-dimensional picture from the usual one- and two-dimensional data presentations. The best study technique is to construct a three-dimensional model, as

described in Ref. 2, by making clear prints of cube cross sections and mounting them to scale in grooved Lucite boxes. Computer-generated color movies with rotating perspective views are also effective in presenting the three-dimensional flow. Since models or movies cannot be presented in a report, we must examine the flow results by studying cross sections in the *i*, *j*, and *k* planes, holding one axis constant at a particular time of interest.

The isobar (lines of constant pressure) cross-sectional plots for the symmetric detonator problem are shown in Figs. 4-6 at 1.275 μs and in Figs. 7-9 at 1.90 μs. The pressure interval is 50 kbar, and the pressure region greater than 400 kbar is shaded. Since the plane wave C-J pressure of PBX 9404 is 365 kbar and the diverging effective C-J pressure is approximately 300 kbar, the regions above 400 kbar must result from either regular or Mach reflection of double- or triple-wave interactions.

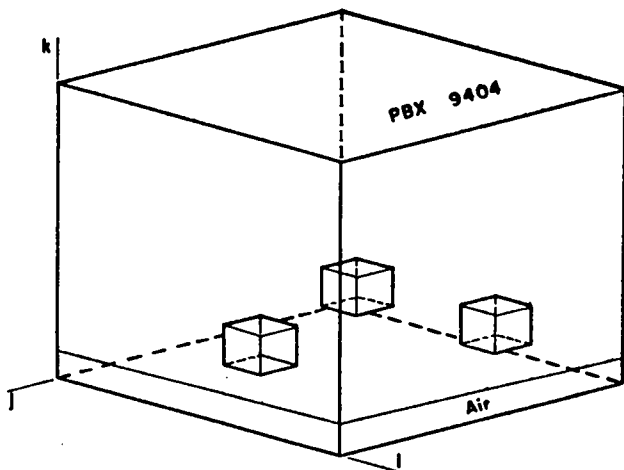
The plots shown in Figs. 4-9 show that the three symmetric detonations interact to give regular and Mach reflection at the three regions where two waves interact. At the center, between the three detonators, a triple-wave interaction occurs that gives a triple-wave regular or a triple-wave Mach reflection, depending on the angle of interaction of the three waves.

The isobar cross-sectional plots for the nonsymmetric detonator problem are shown in Figs. 10-13 at 1.90 μs. The pressure region greater than 400 kbar is shaded.

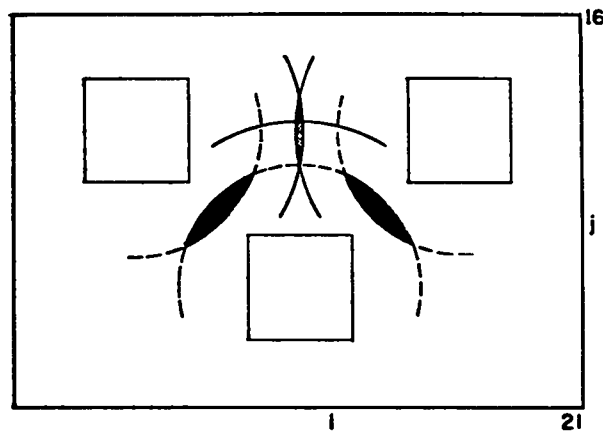
Figures 10 and 12 show the regular and Mach reflections at the two regions where only two waves interact. Figures 11 and 13 show the regular and Mach reflections that occur when both two and three waves interact, resulting in a large triple-wave Mach reflection.

### III. CONCLUSIONS

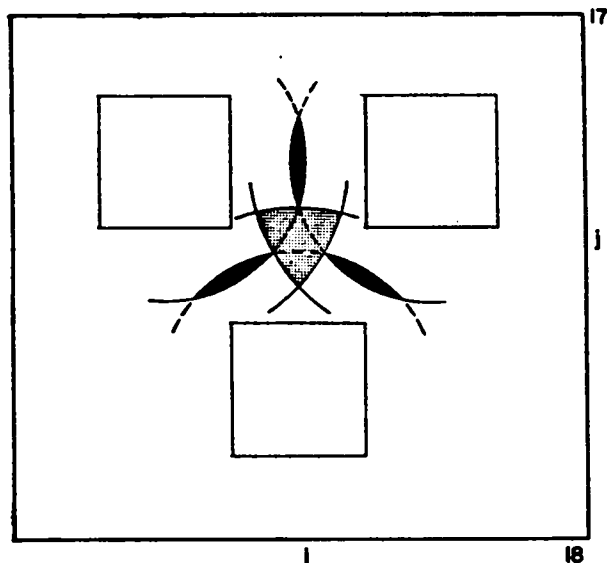
The three-dimensional Eulerian hydrodynamic computer code 3DE has been used to examine the flow resulting from the interaction of three spherically diverging detonation waves. The size and magnitude of the high-pressure double- and triple-wave interactions depend significantly upon the initial relative positions of the detonators. The flow will be examined with double the numerical resolution shown in this report. The initiation mechanism for lower energy detonators, which do not cause prompt initiation of the surrounding explosive, can now be studied.



**Fig. 1.**  
A PBX 9404 cube with three rectangular detonators.

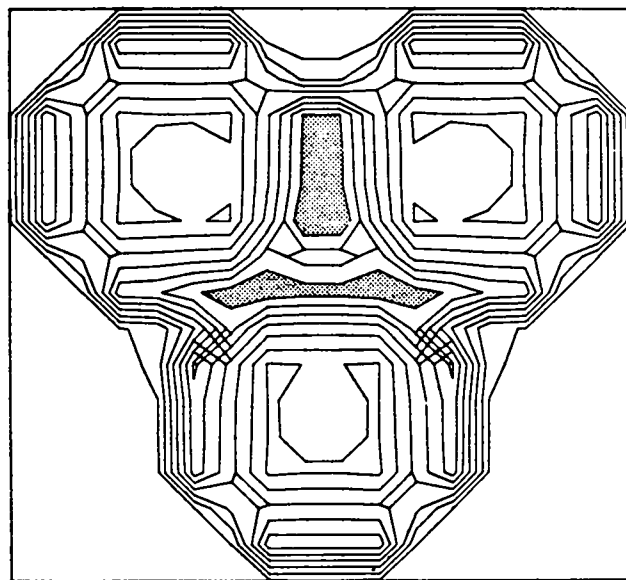


**Fig. 3.**  
The double and triple detonation wave interactions from three nonsymmetric detonators. The dashed lines and dark region show double-wave interaction. The solid lines and dotted region show triple-wave interactions.



**Fig. 2.**  
The double and triple detonation wave interactions from three symmetric detonators. The dashed lines and dark regions show double-wave interaction. The solid lines and dotted region show triple-wave interaction.

T= 1.2750E+00 MS CYCLE 51 DELTA= 5.0000E-02

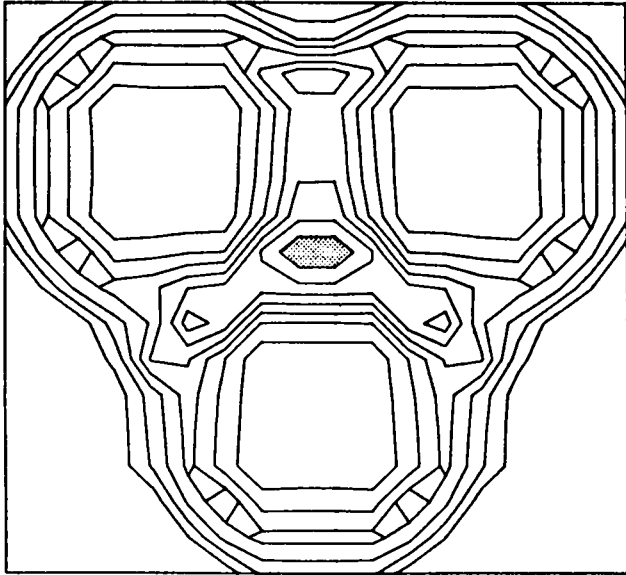


PRESSURE (MEGABARS)

K= 9

**Fig. 4.**  
The symmetric detonator isobar cross section for cell layer  $k$  of 9 at  $1.275 \mu\text{s}$ . The isobar interval is 50 kbar. The regions of double reflection above 400 kbar are shaded.

T= 1.2750E+00 MS CYCLE SI DELTA= 6.0000E-02



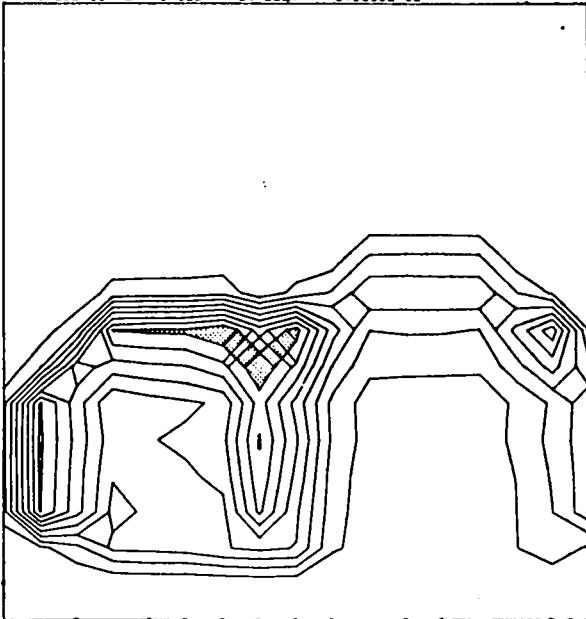
PRESSURE (MEGABARS)

K= 8

Fig. 5.

The symmetric detonator isobar cross section for cell layer k of 8 at 1.275  $\mu$ s. The isobar interval is 50 kbar. The region of triple reflection above 400 kbar is shaded.

T= 1.2750E+00 MS CYCLE SI DELTA= 6.0000E-02



PRESSURE (MEGABARS)

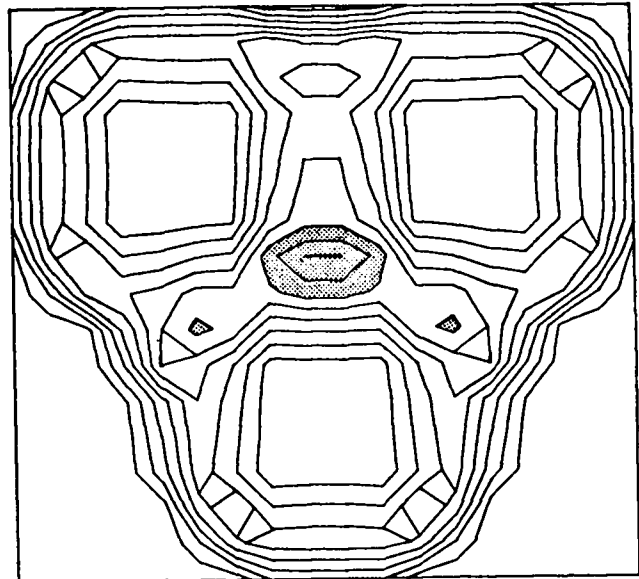
I= 9

Fig. 6.

The symmetric detonator isobar cross section for cell layer i of 9 at 1.275  $\mu$ s. The isobar interval is 50 kbar. The regions of double and triple reflection above 400 kbar are shaded.

**Fig. 7.**  
*The symmetric detonator isobar cross section for cell layer k of 11 at 1.90  $\mu$ s. The isobar interval is 50 kbar. The regions of triple reflection in the center and double reflection on the sides above 400 kbar are shaded.*

T= 1.9000E+00 MS CYCLE 76 DELTA= 5.0000E-02

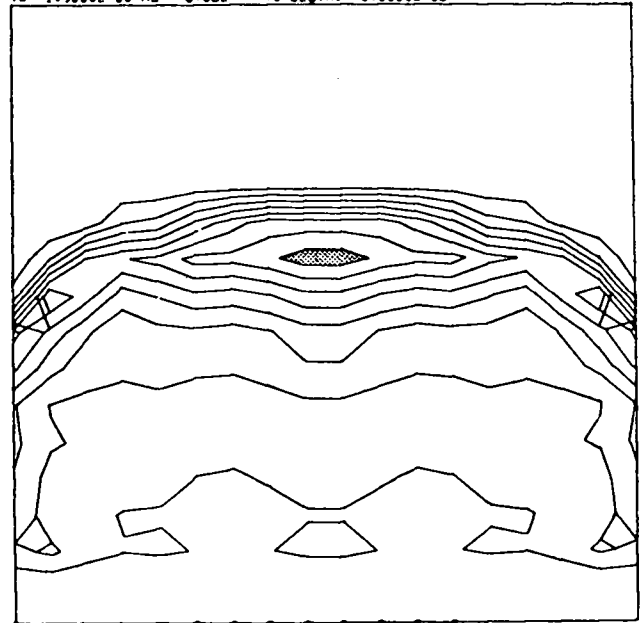


PRESSURE (MEGABARS)

K= 11

**Fig. 8.**  
*The symmetric detonator isobar cross section for cell layer j of 9 at 1.90  $\mu$ s. The isobar interval is 50 kbar. The region of triple reflection above 400 kbar is shaded.*

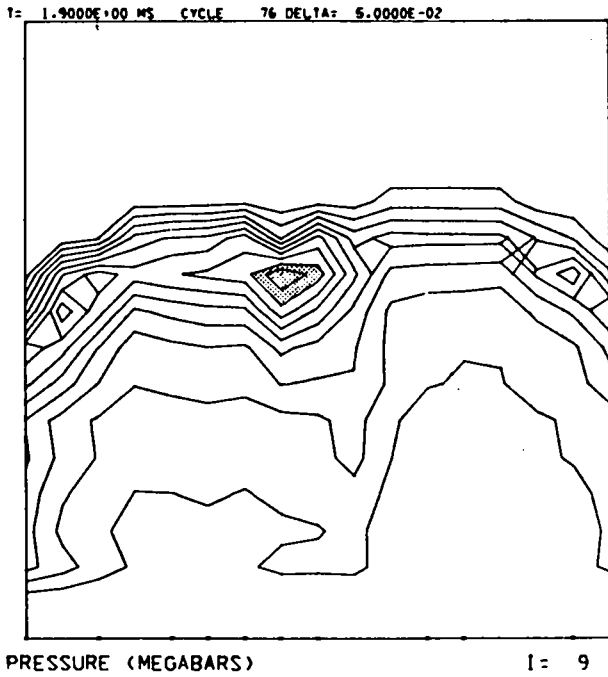
T= 1.9000E+00 MS CYCLE 76 DELTA= 5.0000E-02



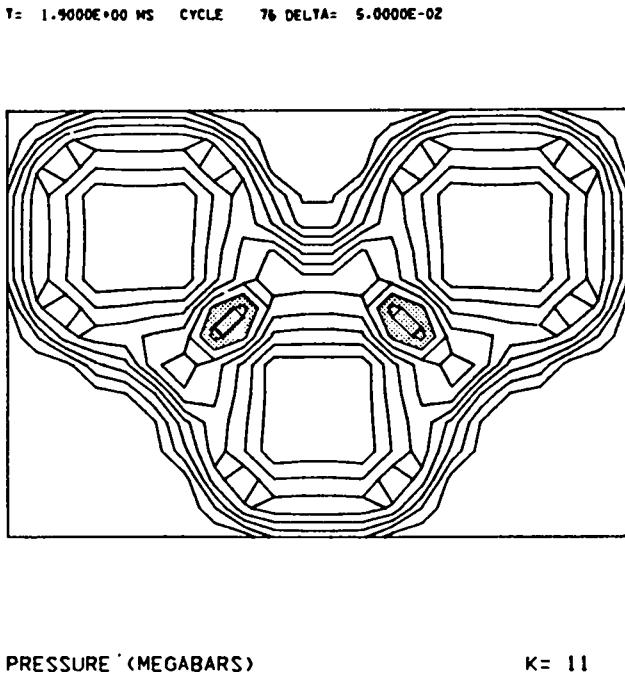
PRESSURE (MEGABARS)

J= 9





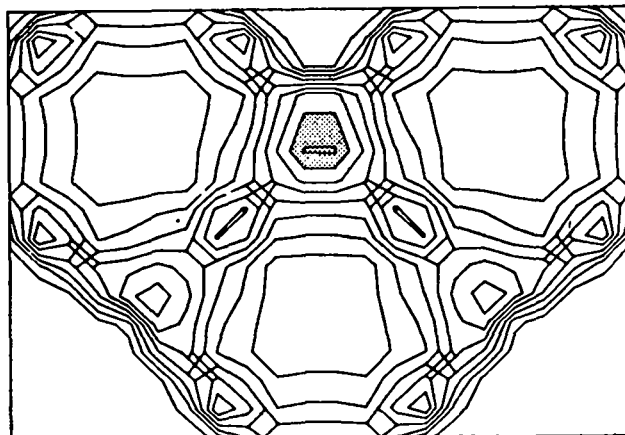
*Fig. 9.*  
*The symmetric detonator isobar cross section for cell layer i of 9 at 1.90  $\mu$ s. The isobar interval is 50 kbar. The region of triple reflection above 400 kbar is shaded.*



*Fig. 10.*  
*The nonsymmetric detonator isobar cross section for cell layer k of 11 at 1.90  $\mu$ s. The isobar interval is 50 kbar. The region of double reflection above 400 kbar is shaded.*

**Fig. 11.**  
*The nonsymmetric detonator isobar cross section for cell layer k of 10 at 1.90  $\mu$ s. The isobar interval is 50 kbar. The region of double and triple reflection above 400 kbar is shaded.*

T= 1.9000E+00 MS CYCLE 76 DELTA= 5.0000E-02

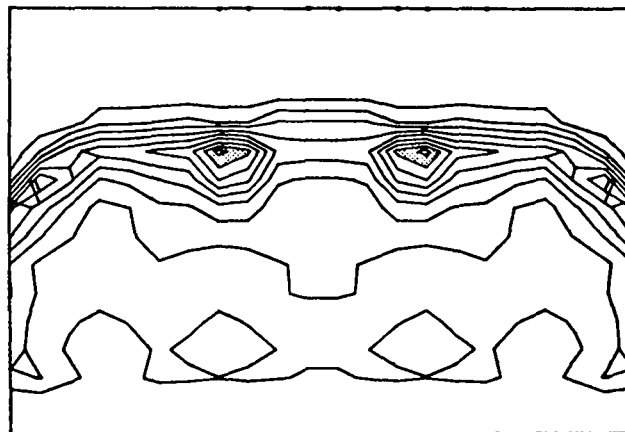


PRESSURE (MEGABARS)

K= 10

**Fig. 12.**  
*The nonsymmetric detonator isobar cross section for cell layer j of 9 at 1.90  $\mu$ s. The isobar interval is 50 kbar. The regions of double reflection above 400 kbar are shaded.*

T= 1.9000E+00 MS CYCLE 76 DELTA= 5.0000E-02



PRESSURE (MEGABARS)

J= 9

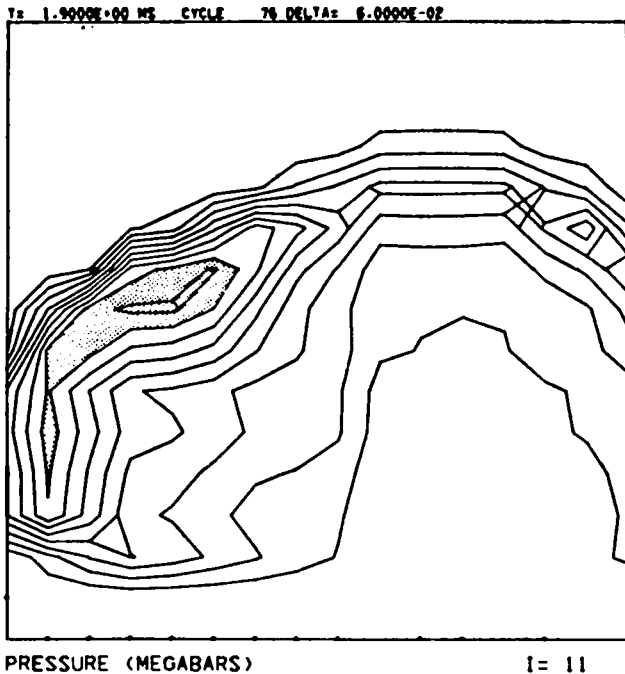


Fig. 13.

The nonsymmetric detonator isobar cross section for cell layer  $i$  of 11 at  $1.90 \mu\text{s}$ . The isobar interval is 50 kbar. The region of double and triple reflection above 400 kbar is shaded.

#### REFERENCES

1. Charles L. Mader, *Numerical Modeling of Detonations* (University of California Press, Berkeley, California, 1979).
2. William R. Gage and Charles L. Mader, "Three-Dimensional Cartesian Particle-in-Cell Calculations," Los Alamos Scientific Laboratory report LA-3422 (1966).
3. W. E. Johnson, "TRIOIL," Gulf General Atomic, San Diego, report GAMD-7310 (1967).
4. C. W. Hirt and J. L. Cook, "Calculating Three-Dimensional Flows Around Structures and Over Rough Terrain," *J. Comput. Phys.* 10, 324 (1972).
5. William E. Pracht, "Calculating Three-Dimensional Fluid Flows at All Speeds with an Eulerian-Lagrangian Computing Mesh," *J. Comput. Phys.* 17, 132 (1975).
6. W. E. Pracht and J. U. Brackbill, "BAAL: A Code for Calculating Three-Dimensional Fluid Flows at All Speeds with EulerianLagrangian Computing Mesh," Los Alamos Scientific Laboratory report LA-6342 (1976).
7. L. R. Stein, R. A. Gentry, and C. W. Hirt, "Computational Simulation of Transient Blast Loading on Three-Dimensional Structures," *Comput. Methods in Appl. Mech. and Eng. (Netherlands)* 11, 57 (1977).
8. M. L. Wilkins, S. J. French, and M. Sorem, "Finite Difference Scheme for Calculating Problems in Three Space Dimensions and Time," 2nd Intern. Conf. on Numerical Methods in Fluid Dynamics, University of California, Berkeley, September 15-19, 1970.
9. Charles L. Mader and Douglas Venable, "Mach Stems Formed by Colliding Cylindrical Detonation Waves," Los Alamos Scientific Laboratory report LA-7869 (1979).

## APPENDIX

### NUMERICAL SOLUTION OF THREE-DIMENSIONAL EULERIAN REACTIVE FLOW

#### I. THE FLOW EQUATIONS

##### The Nomenclature

Quantities pertaining to cell *ijk*

$E_{i,j,k}$	total energy
$I_{i,j,k}$	internal energy
$M_{i,j,k}$	mass
$P_{i,j,k}$	pressure
$P_{i,j,k}^l$	pressure on face <i>l</i>
$Q_{i,j,k}^l$	viscous pressure on face <i>l</i>
$\Delta x, \Delta y, \Delta z$	length of cell sides in x,y,z
$T_{i,j,k}$	temperature
$U_{x,i,j,k}$	x-velocity
$U_{y,i,j,k}$	y-velocity
$U_{z,i,j,k}$	z-velocity
$W_{i,j,k}$	mass fraction of undecomposed explosive
$X_{x,i,j,k}$	momentum in x-direction
$X_{y,i,j,k}$	momentum in y-direction
$X_{z,i,j,k}$	momentum in z-direction
$V_c$	cell volume = $\Delta x \Delta y \Delta z$
$\Delta t$	time increment
$\rho$	density
$m$	mass moved
$iMAX, jMAX, kMAX$	maximum number cells in i,j,k-direction
$PAPP, UAPP, MAPP,$	piston values of pressure, velocity, mass,
$IAPP, WAPP$	energy, and mass fraction

The three-dimensional partial differential equations for nonviscous, nonconducting, compressible fluid flow are

$$\frac{\partial \rho}{\partial t} + U_x \left( \frac{\partial \rho}{\partial x} \right) + U_y \left( \frac{\partial \rho}{\partial y} \right) + U_z \left( \frac{\partial \rho}{\partial z} \right) = -\rho \left( \frac{\partial U_x}{\partial x} + \frac{\partial U_y}{\partial y} + \frac{\partial U_z}{\partial z} \right)$$

$$\rho \left[ \frac{\partial U_x}{\partial t} + U_x \left( \frac{\partial U_x}{\partial x} \right) + U_y \left( \frac{\partial U_x}{\partial y} \right) + U_z \left( \frac{\partial U_x}{\partial z} \right) \right] = -\frac{\partial P}{\partial x}$$

$$\rho \left[ \frac{\partial U_y}{\partial t} + U_x \left( \frac{\partial U_y}{\partial x} \right) + U_y \left( \frac{\partial U_y}{\partial y} \right) + U_z \left( \frac{\partial U_y}{\partial z} \right) \right] = -\frac{\partial P}{\partial y}$$

$$\rho \left[ \frac{\partial U_z}{\partial t} + U_x \left( \frac{\partial U_z}{\partial x} \right) + U_y \left( \frac{\partial U_z}{\partial y} \right) + U_z \left( \frac{\partial U_z}{\partial z} \right) \right] = -\frac{\partial P}{\partial z}$$

$$\rho \left[ \frac{\partial I}{\partial t} + U_x \left( \frac{\partial I}{\partial x} \right) + U_y \left( \frac{\partial I}{\partial y} \right) + U_z \left( \frac{\partial I}{\partial z} \right) \right] = -P \left( \frac{\partial U_x}{\partial x} + \frac{\partial U_y}{\partial y} + \frac{\partial U_z}{\partial z} \right) -$$

In Phase II, the transport terms in the momentum and energy equations may be dropped, resulting in the following set of equations.

$$\rho \frac{\partial U_x}{\partial t} = - \frac{\partial P}{\partial x}$$

$$\rho \frac{\partial U_y}{\partial t} = - \frac{\partial P}{\partial y} \quad \text{Momentum}$$

$$\rho \frac{\partial U_z}{\partial t} = - \frac{\partial P}{\partial z}$$

$$\rho \frac{\partial I}{\partial t} = - P \left( \frac{\partial U_x}{\partial x} + \frac{\partial U_y}{\partial y} + \frac{\partial U_z}{\partial z} \right) \quad \text{Energy}$$

With artificial viscosity these equations become

$$\rho \frac{\partial U_x}{\partial t} = - \frac{\partial (P + Q)}{\partial x}$$

$$\rho \frac{\partial U_y}{\partial t} = - \frac{\partial (P + Q)}{\partial y}$$

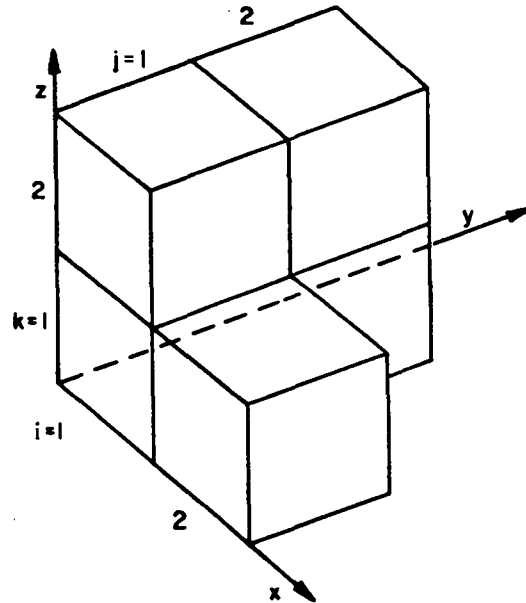
$$\rho \frac{\partial U_z}{\partial t} = - \frac{\partial (P + Q)}{\partial z}$$

$$\begin{aligned} -\rho \frac{\partial I}{\partial t} = & P \left[ \frac{\partial U_x}{\partial x} + \frac{\partial U_y}{\partial y} + \frac{\partial U_z}{\partial z} \right] + \frac{\partial (U_x Q)}{\partial x} - U_x \frac{\partial Q}{\partial x} \\ & + \frac{\partial (U_y Q)}{\partial y} - U_y \frac{\partial Q}{\partial y} + \frac{\partial (U_z Q)}{\partial z} - U_z \frac{\partial Q}{\partial z} \end{aligned}$$

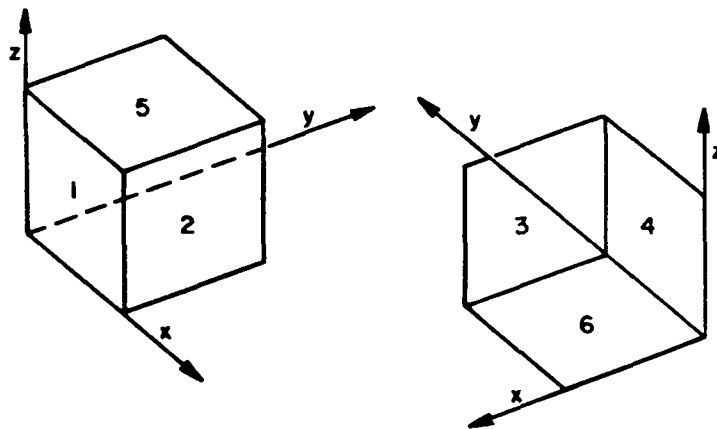
Given some initial conditions, these equations are solved using finite-difference approximations. The fluid is moved by a continuous mass transport method.

## II. THE NUMERICAL TECHNIQUE

The problem is divided into Eulerian cells. The state values are cell-centered; the velocities and positions are at cell corners.



The problem is set up with a cubical lattice of  $iMAX*jMAX*kMAX$  cells (in each direction). Every cell has three indices ( $ijk$ ) associated with it, each index having a range from 1 to  $iMAX$ ,  $jMAX$ , or  $kMAX$ . The  $x,y,z$ -coordinates of the corner nearest the origin of cell  $ijk$  are then  $(i - 1)\Delta x$ ,  $(j - 1)\Delta y$ ,  $(k - 1)\Delta z$ , where  $\Delta x, \Delta y$ , and  $\Delta z$  are the lengths of the side of a cell. The faces of each cell are numbered one through six.



The faces of cell  $ijk$  have indices

face 1  $i, j - 1/2, k$   
 face 2  $i + 1/2, j, k$   
 face 3  $i, j + 1/2, k$   
 face 4  $i - 1/2, j, k$ .

The center of the cell is at  $i + 1/2, j + 1/2, k + 1/2$ . Face boundaries 1, 4, and 6 are piston or continuum whereas face boundaries 2, 3, and 5 are continuum only.

## PHASE I

If first cycle, skip to IA.

$$M_{i,j,k}^{n+1} = M_{i,j,k}^n + \Delta m_{i,j,k}$$

$$U_{x,i,j,k} = \frac{\bar{X}_{x,i,j,k}}{M_{i,j,k}}$$

$$U_{y,i,j,k} = \frac{\bar{X}_{y,i,j,k}}{M_{i,j,k}}$$

$$U_{z,i,j,k} = \frac{\bar{X}_{z,i,j,k}}{M_{i,j,k}}$$

$$\bar{E}_{i,j,k} = \Delta E_{i,j,k} + E_{i,j,k}$$

$$I_{i,j,k} = \frac{\bar{E}_{i,j,k}}{M_{i,j,k}} - \frac{1}{2} (U_{x,i,j,k}^2 + U_{y,i,j,k}^2 + U_{z,i,j,k}^2)$$

$$1A \text{ time}^{n+1} = \text{time}^n + \Delta \tau$$

$$\Delta m_{i,j,k} = 0.0$$

$$\Delta E_{i,j,k} = 0.0$$

The pressure and temperature are calculated from the density, internal energy, and cell mass fractions using the HOM, HOM2S, HOM2G, HOMSG, or HOM2SG described in Appendix C of Ref. 1. The Arrhenius, C-J volume, and Forest Fire burns are identical to those described in Appendix A of Ref. 1.

## PHASE II

### A. Calculate the pressures on the six faces of each cell.

If a cell face is on a boundary, its pressure is set equal to the cell pressure. Otherwise,

$$P_{i,j,k}^1 = \frac{1}{2} (P_{i,j,k} + P_{i,j-1,k}) \quad \text{face 1 of cell } ijk$$

$$P_{i,j,k}^2 = \frac{1}{2} (P_{i,j,k} + P_{i+1,j,k}) \quad \text{face 2 of cell } ijk$$

$$P_{i,j,k}^3 = \frac{1}{2} (P_{i,j,k} + P_{i,j+1,k}) \quad \text{face 3 of cell } ijk$$

$$P_{i,j,k}^4 = \frac{1}{2} (P_{i,j,k} + P_{i-1,j,k}) \quad \text{face 4 of cell } ijk$$

$$P_{i,j,k}^5 = \frac{1}{2} (P_{i,j,k} + P_{i,j,k+1}) \quad \text{face 5 of cell } ijk$$

$$P_{i,j,k}^6 = \frac{1}{2} (P_{i,j,k} + P_{i,j,k-1}) \quad \text{face 6 of cell } ijk$$

### B. Calculate the viscosities on the six faces of each cell.

If the viscosity is negative, it is set to zero. If a cell face is on a boundary, its viscosity is set to zero.

$$Q_{i,j,k}^1 = \frac{\kappa M_{i,j,k} M_{i,j-1,k} (U_{y,i,j-1,k} - U_{y,i,j,k})}{2(M_{i,j,k} + M_{i,j-1,k})V_c}$$

$$Q_{i,j,k}^2 = \frac{\kappa M_{i,j,k} M_{i+1,j,k} (U_{x,i,j,k} - U_{x,i+1,j,k})}{2(M_{i,j,k} + M_{i+1,j,k})V_c}$$

$$Q_{i,j,k}^3 = \frac{\kappa M_{i,j,k} M_{i,j+1,k} (U_{y,i,j,k} - U_{y,i,j+1,k})}{2(M_{i,j,k} + M_{i,j+1,k})V_c}$$

$$Q_{i,j,k}^4 = \frac{\kappa M_{i,j,k} M_{i-1,j,k} (U_{x,i-1,j,k} - U_{x,i,j,k})}{2(M_{i,j,k} + M_{i-1,j,k})V_c}$$

$$Q_{i,j,k}^5 = \frac{\kappa M_{i,j,k} M_{i,j,k+1} (U_{z,i,j,k} - U_{z,i,j,k+1})}{2(M_{i,j,k} + M_{i,j,k+1})V_c}$$

$$Q_{i,j,k}^6 = \frac{\kappa M_{i,j,k} M_{i,j,k-1} (U_{z,i,j,k-1} - U_{z,i,j,k})}{2(M_{i,j,k} + M_{i,j,k-1})V_c}$$



C. Calculate the tentative velocities according to the momentum equations.

$$\bar{u}_{x,i,j,k} = u_{x,i,j,k} + \frac{\Delta t \Delta y \Delta z}{M_{i,j,k}} \left( P_{i,j,k}^4 - P_{i,j,k}^2 + Q_{i,j,k}^4 - Q_{i,j,k}^2 \right)$$

$$\bar{u}_{y,i,j,k} = u_{y,i,j,k} + \frac{\Delta t \Delta x \Delta z}{M_{i,j,k}} \left( P_{i,j,k}^1 - P_{i,j,k}^3 + Q_{i,j,k}^1 - Q_{i,j,k}^3 \right)$$

$$\bar{u}_{z,i,j,k} = u_{z,i,j,k} + \frac{\Delta t \Delta y \Delta x}{M_{i,j,k}} \left( P_{i,j,k}^6 - P_{i,j,k}^5 + Q_{i,j,k}^6 - Q_{i,j,k}^5 \right)$$

D. Calculate tentative cell internal energies.

1. If a neighbor cell is on a boundary, the average velocity for that face is  $\frac{1}{2}(\bar{U}_{i,j,k} + U_{i,j,k})$ . If the boundary is a piston, the velocity for that face is  $U_{APP}$ .

2. For the first VCNT (25) cycles the piston energy is constrained as follows.

$$\begin{aligned} \bar{I}_{i,j,k} &= \frac{1}{2} \left( P_{i,j,k} + Q_{i,j,k}^5 \right) \left( \frac{1}{\rho_0} - \frac{1}{\rho_{i,j,k}} \right) \quad \text{for } \frac{1}{\rho_0} > \frac{1}{\rho} \quad , \\ &= I_{i,j,k} \quad \text{for } \frac{1}{\rho_0} < \frac{1}{\rho} \end{aligned}$$

3. Calculate the following quantities.

$$U_{x,i,j,k}^4 = \frac{1}{4} \left( \bar{u}_{x,i,j,k} + u_{x,i,j,k} + \bar{u}_{x,i-1,j,k} + u_{x,i-1,j,k} \right)$$

$$U_{x,i,j,k}^2 = \frac{1}{4} \left( \bar{u}_{x,i,j,k} + u_{x,i,j,k} + \bar{u}_{x,i+1,j,k} + u_{x,i+1,j,k} \right)$$

$$U_{y,i,j,k}^1 = \frac{1}{4} \left( \bar{u}_{y,i,j,k} + u_{y,i,j,k} + \bar{u}_{y,i,j-1,k} + u_{y,i,j-1,k} \right)$$

$$U_{y,i,j,k}^3 = \frac{1}{4} \left( \bar{u}_{y,i,j,k} + u_{y,i,j,k} + \bar{u}_{y,i,j+1,k} + u_{y,i,j+1,k} \right)$$

$$U_{z,i,j,k}^6 = \frac{1}{4} \left( \bar{u}_{z,i,j,k} + u_{z,i,j,k} + \bar{u}_{z,i,j,k-1} + u_{z,i,j,k-1} \right)$$

$$U_{z,i,j,k}^5 = \frac{1}{4} \left( \bar{u}_{z,i,j,k} + u_{z,i,j,k} + \bar{u}_{z,i,j,k+1} + u_{z,i,j,k+1} \right)$$

!

4. The tentative cell energy is then

$$\begin{aligned}
 \bar{I}_{i,j,k} = & I_{i,j,k} + \frac{\Delta t}{M_{i,j,k}} \left\{ P_{i,j,k} \left[ \left( U_{x,i,j,k}^4 - U_{x,i,j,k}^2 \right) \Delta y \Delta z \right. \right. \\
 & + \Delta x \Delta z \left( U_{y,i,j,k}^1 - U_{y,i,j,k}^3 \right) + \left( U_{z,i,j,k}^6 - U_{z,i,j,k}^5 \right) \Delta x \Delta y \left. \right] \\
 & + \left( Q_{i,j,k}^4 U_{x,i,j,k}^4 - Q_{i,j,k}^2 U_{x,i,j,k}^2 \right) \Delta y \Delta z \\
 & + \Delta x \Delta z \left( Q_{i,j,k}^1 U_{y,i,j,k}^1 - Q_{i,j,k}^3 U_{y,i,j,k}^3 \right) \\
 & + \left( Q_{i,j,k}^6 U_{z,i,j,k}^6 - Q_{i,j,k}^5 U_{z,i,j,k}^5 \right) \Delta x \Delta y \\
 & - \frac{\bar{U}_{x,i,j,k} + U_{x,i,j,k}}{2} \left( Q_{i,j,k}^4 - Q_{i,j,k}^2 \right) \Delta y \Delta z \\
 & - \frac{\bar{U}_{y,i,j,k} + U_{y,i,j,k}}{2} \left( Q_{i,j,k}^1 - Q_{i,j,k}^3 \right) \Delta x \Delta z \\
 & \left. - \frac{\bar{U}_{z,i,j,k} + U_{z,i,j,k}}{2} \left( Q_{i,j,k}^6 - Q_{i,j,k}^5 \right) \Delta x \Delta y \right\} .
 \end{aligned}$$

E. Calculate total cell energy and momenta.

$$\begin{aligned}
 E_{i,j,k} &= M_{i,j,k} \left[ \bar{I}_{i,j,k} + \frac{1}{2} \left( \bar{U}_{x,i,j,k}^2 + \bar{U}_{y,i,j,k}^2 + \bar{U}_{z,i,j,k}^2 \right) \right] \\
 X_{x,i,j,k} &= M_{i,j,k} \bar{U}_{x,i,j,k} \\
 X_{y,i,j,k} &= M_{i,j,k} \bar{U}_{y,i,j,k} \\
 X_{z,i,j,k} &= M_{i,j,k} \bar{U}_{z,i,j,k}
 \end{aligned}$$

### PHASE III

Mass movement occurs if the pressure of the cell from which it moves is greater than FREPR ( $1.1 \times 10^{-6}$ ) or if the cell is in tension.

Following the method described in Appendix C of Ref. 1, the mass movement is calculated as in the case described for slab geometry. Mass is moved either into or out of a cell across each of its six cell faces. When mass moves into a cell it is designated an acceptor cell, and when mass moves out of a cell it is designated a donor cell. During a time cycle,  $\Delta m$  is the total change in a cell and is the sum of all mass movements across all faces of the cell. Since cells are contiguous, a mass movement across a cell face increases the  $\Delta m$  of the acceptor cell and decreases that of the donor cell.

A. Calculate  $\hat{\rho}$  for donor cells.

$$\hat{\rho}_{i,j,k}^n = \rho_{i,j,k}^n \left[ 1.0 - \frac{\Delta t}{2\Delta x} (u_{x,i+1,j,k}^n - u_{x,i-1,j,k}^n) - \frac{\Delta t}{2\Delta y} (u_{y,i,j+1,k}^n - u_{y,i,j-1,k}^n) - \frac{\Delta t}{2\Delta z} (u_{z,i,j,k+1}^n - u_{z,i,j,k-1}^n) \right]$$

Exceptions:

Piston boundary

face 1  $U_{y,i,j-1,k} = U_{APP}$

face 4  $U_{x,i-1,j,k} = U_{APP}$

face 6  $U_{z,i,j,k-1} = U_{APP}$

Continuum boundaries

face 1  $U_{y,i,j+1,k} = U_{y,i,j,k}$

face 2  $U_{x,i+1,j,k} = U_{x,i,j,k}$

face 3  $U_{y,i,j+1,k} = U_{y,i,j,k}$

face 4  $U_{x,i+1,j,k} = U_{x,i,j,k}$

face 5  $U_{z,i,j,k+1} = U_{z,i,j,k}$

face 6  $U_{z,i,j,k-1} = U_{z,i,j,k}$

B. Calculate mass movement across face 1.

$$\Delta = \frac{\frac{1}{2} (\bar{u}_{y,i,j,k} + \bar{u}_{y,i,j-1,k}) \frac{\Delta t}{\Delta y}}{1 + (\bar{u}_{y,i,j,k} - \bar{u}_{y,i,j-1,k}) \frac{\Delta t}{\Delta y}}$$

If  $\Delta \geq 0$ , the mass moves from donor cell  $i,j-1,k$  to cell  $i,j,k$ . Mass donated to cell  $i,j,k$  is subscripted  $l,m,n$ .

$$m_{l,m,n} = (\hat{\rho}_{i,j-1,k}) (\Delta) V_c$$

If  $\Delta \leq 0$ , the mass moves from  $i,j,k$  to  $i,j-1,k$ .

$$m_{i,j,k} = (\hat{\rho}_{i,j,k}) |\Delta| V_c$$

C. Calculate mass movement across face 4.

$$\Delta = \frac{\frac{1}{2} (\bar{u}_{x,i,j,k} + \bar{u}_{x,i-1,j,k}) \frac{\Delta t}{\Delta x}}{1 + (\bar{u}_{x,i,j,k} - \bar{u}_{x,i-1,j,k}) \frac{\Delta t}{\Delta x}}$$

If  $\Delta \geq 0$ , the mass moves from donor cell  $i-1,j,k$ , to cell  $i,j,k$ .

$$m_{l,m,n} = (\hat{\rho}_{i-1,j,k}) (\Delta) V_c$$

If  $\Delta \leq 0$ , the mass moves from  $i,j,k$  to  $i-l,j,k$ .

$$m_{i,j,k} = (\hat{\rho}_{i,j,k})(|\Delta|)v_c$$

**D. Calculate movement across face 6.**

$$\Delta = \frac{\frac{1}{2}(\bar{u}_{z,i,j,k} + \bar{u}_{z,i,j,k-1}) \frac{\Delta t}{\Delta z}}{1 + (\bar{u}_{z,i,j,k} - \bar{u}_{z,i,j,k-1}) \left(\frac{\Delta t}{\Delta z}\right)}$$

If  $\Delta \geq 0$ , the mass moves from donor cell  $i,j,k-1$  to cell  $i,j,k$ .

$$m_{l,m,n} = (\hat{\rho}_{i,j,k-1})(\Delta)v_c$$

If  $\Delta \leq 0$ , the mass moves from  $i,j,k$  to  $i,j,k-l$ .

$$m_{i,j,k} = (\hat{\rho}_{i,j,k})(|\Delta|)v_c$$

Mass movements across faces 2, 3 and 5 are described by faces 1, 4, and 7 except at boundaries.

**E. Boundaries for B, C, and D are treated as follows.**

Piston boundaries use applied mass (MAPP) and applied particle velocity (UAPP).  
Continuum boundaries use to calculate  $\Delta$ .

$$\text{face 1} \quad \Delta = \frac{1}{2}(3\bar{u}_{y,i,j,k} - \bar{u}_{y,i,j+1,k}) \frac{\Delta t}{\Delta y}$$

$$\text{face 4} \quad \Delta = \frac{1}{2}(3\bar{u}_{x,i,j,k} - \bar{u}_{x,i+1,j,k}) \frac{\Delta t}{\Delta x}$$

$$\text{face 6} \quad \Delta = \frac{1}{2}(3\bar{u}_{z,i,j,k} - \bar{u}_{z,i,j,k+1}) \frac{\Delta t}{\Delta z}$$

$$\text{face 2} \quad \Delta = \frac{1}{2}(3\bar{u}_{x,i,j,k} - \bar{u}_{x,i-1,j,k}) \frac{\Delta t}{\Delta x}$$

$$\text{face 3} \quad \Delta = \frac{1}{2}(3\bar{u}_{y,i,j,k} - \bar{u}_{y,i,j-1,k}) \frac{\Delta t}{\Delta y}$$

$$\text{face 5} \quad \Delta = \frac{1}{2}(3\bar{u}_{z,i,j,k} - \bar{u}_{z,i,j,k-1}) \frac{\Delta t}{\Delta z}$$

**F. Calculate  $m$  for faces 1, 4, and 6 by adding to cell quantities if the face is an acceptor cell and subtracting if a face is a donor cell. Mass is donated by cell  $(l,m,n)$  to cell  $(i,j,k)$ .**

$$\Delta m_{i,j,k} = \sum m_{l,m,n} - \sum m_{i,j,k}$$

For unmixed cells of the same material,

$$\Delta E_{i,j,k} = \sum m_{l,m,n} \frac{E_{l,m,n}}{M_{l,m,n}} - \sum m_{i,j,k} \frac{E_{i,j,k}}{M_{i,j,k}}$$

For unmixed cells containing an explosive,

$$w_{i,j,k}^n = w_{i,j,k} + \sum_{\ell,m,n}^m \frac{\ell_{\ell,m,n}}{M_{\ell,m,n}} w_{\ell,m,n} - \sum_{i,j,k}^m \frac{m_{i,j,k}}{M_{i,j,k}} w_{i,j,k} \quad ,$$

$$\bar{x}_{x,i,j,k} = x_{x,i,j,k} + \sum_{\ell,m,n}^m \frac{\ell_{\ell,m,n}}{M_{\ell,m,n}} \bar{u}_{x,\ell,m,n} - \sum_{i,j,k}^m \frac{m_{i,j,k}}{M_{i,j,k}} \bar{u}_{x,i,j,k} \quad ,$$

$$\bar{x}_{y,i,j,k} = x_{y,i,j,k} + \sum_{\ell,m,n}^m \frac{\ell_{\ell,m,n}}{M_{\ell,m,n}} \bar{u}_{y,\ell,m,n} - \sum_{i,j,k}^m \frac{m_{i,j,k}}{M_{i,j,k}} \bar{u}_{y,i,j,k} \quad ,$$

$$\bar{x}_{z,i,j,k} = x_{z,i,j,k} + \sum_{\ell,m,n}^m \frac{\ell_{\ell,m,n}}{M_{\ell,m,n}} \bar{u}_{z,\ell,m,n} - \sum_{i,j,k}^m \frac{m_{i,j,k}}{M_{i,j,k}} \bar{u}_{z,i,j,k} \quad .$$

G. The mixed cells are treated as described in Appendix C of Ref. 1. Determine the composition of the mass to be moved from the donor to the acceptor cell as follows. Materials common to both the donor and acceptor cells are moved according to the mass fractions of common materials in the acceptor cell. If the donor and acceptor cells have no common materials, then mass is moved according to the mass fractions of the donor cell. The mass to be moved from the donor cell has the density and energy determined for that component or components by the mixture equation-of-state calculation in Phase 1.

Printed in the United States of America  
 Available from  
 National Technical Information Service  
 US Department of Commerce  
 5285 Port Royal Road  
 Springfield, VA 22161  
 Microfiche \$3.50 (A01)

Page Range	Domestic Price	NTIS Price Code	Page Range	Domestic Price	NTIS Price Code	Page Range	Domestic Price	NTIS Price Code	Page Range	Domestic Price	NTIS Price Code
001-025	\$ 5.00	A02	151-175	\$11.00	A08	301-325	\$17.00	A14	451-475	\$23.00	A20
026-050	6.00	A03	176-200	12.00	A09	326-350	18.00	A15	476-500	24.00	A21
051-075	7.00	A04	201-225	13.00	A10	351-375	19.00	A16	501-525	25.00	A22
076-100	8.00	A05	226-250	14.00	A11	376-400	20.00	A17	526-550	26.00	A23
101-125	9.00	A06	251-275	15.00	A12	401-425	21.00	A18	551-575	27.00	A24
126-150	10.00	A07	276-300	16.00	A13	426-450	22.00	A19	576-600	28.00	A25
									601-up	†	A99

†Add \$1.00 for each additional 25-page increment or portion thereof from 601 pages up.