

LA-8413-PR

Progress Report

C.2  
2

**Armor Defeat Mechanisms,  
Alternative Materials Selection**

February—April 1980

University of California



**DO NOT CIRCULATE**

**PERMANENT RETENTION**

**REQUIRED BY CONTRACT**



**LOS ALAMOS SCIENTIFIC LABORATORY**

Post Office Box 1663 Los Alamos, New Mexico 87545

This is the first report in this series.

This report was not edited by the Technical Information staff.

This work was supported by the Air Force Armament Training Laboratory.

This report was prepared as an account of work sponsored by the United States Government. Neither the United States nor the United States Department of Energy, nor any of their employees, makes any warranty, express or implied, or assumes any legal liability or responsibility for the accuracy, completeness, or usefulness of any information, apparatus, product, or process disclosed, or represents that its use would not infringe privately owned rights. Reference herein to any specific commercial product, process, or service by trade name, mark, manufacturer, or otherwise, does not necessarily constitute or imply its endorsement, recommendation, or favoring by the United States Government or any agency thereof. The views and opinions of authors expressed herein do not necessarily state or reflect those of the United States Government or any agency thereof.

# Armor Defeat Mechanisms, Alternative Materials Selection

February—April 1980

Compiled by

J. M. Dickinson 4365

Contributors

P. E. Armstrong	C. W. Mautz
K. V. Davidson	J. F. Muller
C. F. Frantz	A. D. Rollett
S. S. Hecker	D. J. Sandstrom
C. A. Javorsky	W. H. Zimmer
T. I. Jones	



ARMOR DEFEAT MECHANISMS,  
ALTERNATIVE MATERIALS SELECTION

FEBRUARY--APRIL 1980

Compiled by  
J. M. Dickinson

ABSTRACT

Materials characterization and selection studies on liner materials for shaped charge projectiles are discussed. Ductility measurements were made over a strain rate of  $10^{-3}$  to  $10^4$   $S^{-1}$  in tension. Results of compression tests, biaxial stretching tests, and Taylor anvil tests are discussed. Detailed fabrication history, microstructural analysis, and trace element chemical analysis were reported for most of the materials.

## I. Introduction

We are planning to examine the properties of six different uranium materials as a function of strain rate during FY 80. The choice of materials selected for these examinations has been changed several times to respond to immediate needs of the general armor defeat mechanism program. This has resulted in characterization of materials that have been fired as actual liners, rather than the originally planned materials, and could actually increase the utility of the program.

The materials now being examined or prepared are listed in Table I. A number is assigned to each which should help clear up some of the confusion that has been occurring when talking about the liner shot results and the materials used.

Chemical analysis results shown in Table II have been obtained on three of these materials, the CM3-8480, the 69072 - and two of the CMB-6 castings, numbers 70227 and 70233. The < sign in Table II indicates that the amount of the element present was less than the limit of the analysis. Chemical analysis for hydrogen and carbon have been omitted from the table, since the variation in some of the results was greater than what we think is reasonable. Samples have been resubmitted and results will be reported later.

Additional materials, particularly alloys of uranium, will be added to this list for evaluation during the next fiscal year. We particularly want to examine uranium alloys having different phases, alloys that do not undergo phase transformations and alloys with better corrosion resistance than pure uranium.

In addition to the materials listed in Table I, we have examined a fine grained randomly oriented uranium, LA2233, for another program and have included some of the data in this report for comparison purposes.

TABLE I  
MATERIALS SLATED FOR CHARACTERIZATION DURING FY 80

<u>Material</u>	<u>General Description</u>	<u>Corresponding Mautz Shot No.</u>
U CM3 8480	Y-12 fine grained < 100 ppm C	M3-E-4760-4761
U 69072-	Y-12 run-of-the-mill, typical production uranium	M3-E-4795
U CMB-6-70227 <sup>(1)</sup> 70233 70234	LASL as cast, three castings were made.	M3-E-4763 M3-E-4764
U CMB-6-C1-900	LASL - extruded, forged and rolled, low C	
U CMB-6-C1-901	LASL - extruded forged rolled, very low C	
U-7.5 wt% Nb	LASL arc cast - extruded, forged and rolled, medium carbon	

(1) Material U-70227 and 70233 were used for shots number E-4763 and 4764 but the identity of the castings were not kept separate during machining. Since all three castings were made in the same way from the same material, they should be identical. U-CMB-6-70234 was used for characterization studies.

TABLE II  
CHEMICAL ANALYSIS OF URANIUM USED BY MAUTZ

Element	Y-12 Sheet CM3-8480	CMB-6 Castings		Y-12 Sheet 69072-27
	ppm	70227 ppm	70233 ppm	ppm
Li	< 0.2	< 0.2	< 0.2	< 0.2
Mg	50	35	6	6
Ca	6	< 6	12	< 6
Mn	12	12	12	35
Cu	8	7	10	25
Nb	<12	<35	<35	<12
Sn	< 1	< 1	< 1	< 1
W	< 5	< 6	< 6	< 6
Be	< 0.2	< 0.2	< 0.2	< 0.2
Al	30	30	25	13
Ti	< 4	< 4	< 4	< 4
Fe	70	50	70	120
Zn	<30	<30	<30	<30
Mo	4	< 4	< 4	10
Sb	< 6	< 6	< 5	< 6
Pb	7	6	8	6
B	0.6	0.2	0.4	0.7
Si	600	600	600	240
V	< 4	< 4	< 4	< 4
Co	< 7	< 7	< 7	< 7
Sr	< 6	<50	<50	<50
Ag	< 1	< 1	< 1	< 1
Ba	< 6	< 6	< 6	< 6
Bi	< 2	< 2	< 2	< 2
Na	5	2	5	1
P	<120	<120	<120	<120
Cr	2	2	2	10
Ni	12	12	12	30
Zr	<35	<35	<35	<12
Cd	< 2	< 2	< 2	< 2
Ta	<50	<60	<60	<60

## II. Examination of a Fine Grained Isotropic Uranium

Samples of a fine grained isotropic uranium prepared many years ago by CMB-6 at LASL and extensively tested in compression in a cam plastometer by Hockett<sup>1</sup> were obtained to serve as a comparison to the highly anisotropic (thickness vs plane) uranium, CM3-8480, used in Mautz's shot numbers E-4760 and 4761. This isotropic uranium which will be identified as uranium, LA 2233, was examined in tension, compression and using the Taylor Anvil test.

The isotropic uranium contained a small amount of hydrogen from the fabrication processes which would reduce ductility, so vacuum outgasings were performed on two samples. The results of tensile testing these materials at room temperature and at low strain rates ( $2 \times 10^{-5}$  m/s velocity or about  $8 \times 10^{-4} \text{ s}^{-1}$  strain rate) are shown in Table III. Hydrogen analysis on the sample that was outgassed 400°C showed about 0.17 ppm hydrogen. A second sample was outgassed for one hour at 600°C and showed a somewhat higher ductility. Hydrogen contents are pending.

The grip ends of the 400°C outgassed tensile specimens were remachined to 7.62-mm-diam x 25.4-mm-long Taylor anvil samples. One test has been conducted at a velocity of 150 m/s with the strain results plotted in Fig. 1. The negative axial strain reached a maximum of 34%, while the maximum radial strain was about 29%. A second test was conducted at a velocity of 202 m/s. The sample failed by 45° shear at the impact face, with several small pieces breaking away from the periphery. The strain results are plotted, Fig. 2. The sample was too distorted near the impact face to obtain useful strain measurements. Figure 3 shows a photograph of the two samples. The sample tested at 150 m/s exhibited a shape profile similar to the copper samples reported earlier. The deformed cross section on the impact end was essentially circular, confirming the fact that this material is plastically isotropic in the direction tested. It has previously been shown to be a very isotropic material in all directions.

Compression tests on the fine-grained, randomly-oriented material showed significant differences from the tension tests, as shown in Fig. 4. The macroscopic yield stress is considerably lower in compression, but is followed by a very high work hardening rate. This result suggests that different deformation mechanisms may be activated in the two cases. It.

<sup>1</sup> Hockett, J. LA 2233, 1959



TABLE III

RESULTS OF ROOM TEMPERATURE TENSILE TESTS ON LA 2233,  
A FINE GRAINED ISOTROPIC URANIUM, AT A STRAIN RATE OF  $8 \times 10^{-4} \text{ s}^{-1}$

<u>Sample No.</u> <u>(notebook)</u>	<u>YS</u> <u>(KSI)</u>	<u>UTS</u> <u>(KSI)</u>	<u>Uniform</u> <u>elong.%</u>	<u>Total</u> <u>elong.%</u>	<u>RA</u> <u>%</u>	<u>R<sup>(3)</sup></u> <u>1.0</u>	<u>Z/X<sup>(4)</sup></u> <u>1.0</u>
PA-2-139-3 <sup>(1)</sup>	44.5	124.4	17.8	29.8	31.5	1.0	1.0
PA-2-139-9 <sup>(2)</sup>	47.9	116.6	22.9	33.6	37.9	1.0	1.0

(1) ASTM 1/4 inch diam specimen, outgassed 1 h at 400°C.

(2) ASTM 1/4 inch diam specimen, outgassed 1 h at 600°C.

(3) R is ratio of in-plane to through-thickness diametrical elongations in region of uniform elongation.

(4) Z/X is a measure of through-thickness to in-plane strength per discussion in December-January report.

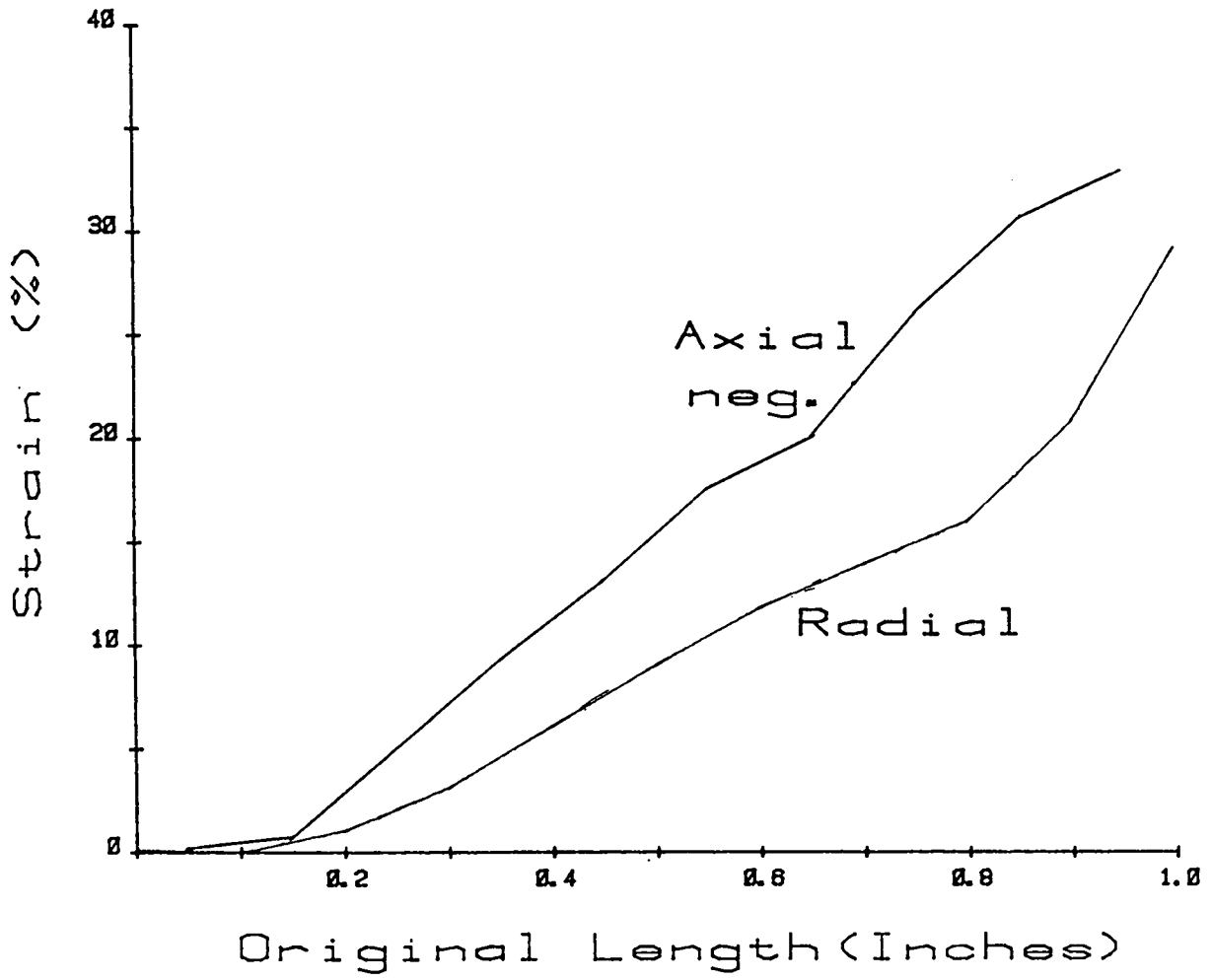

Fig. 1. Plastic deformation of an unalloyed uranium Taylor anvil specimen after impact at 150 m/s. The material is LA 2233 uranium.

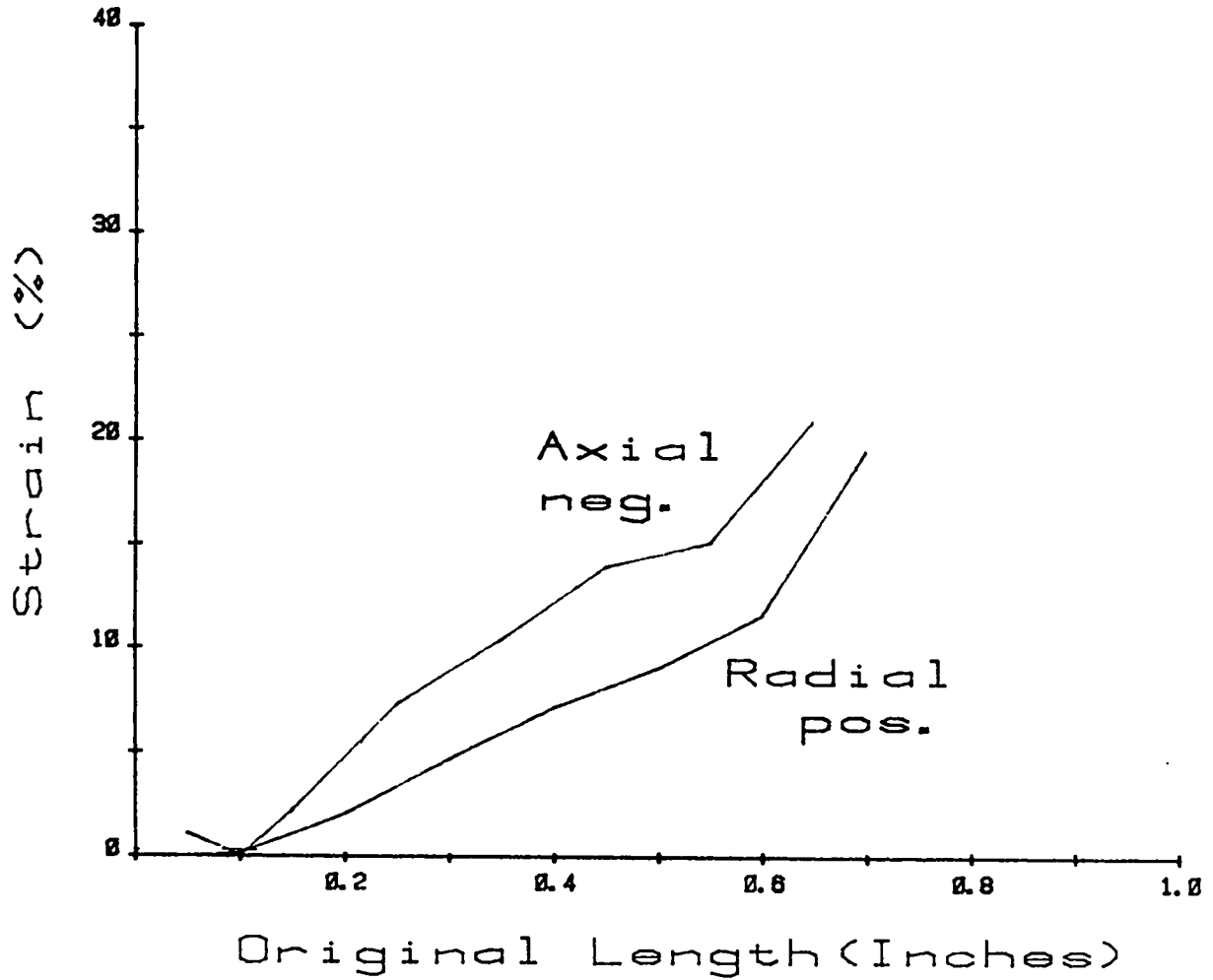

Fig. 2. Plastic deformation of an unalloyed uranium specimen similar to that shown in Fig. 1, except the impact velocity was 202 m/s and the sample partially fractured in the region beyond 17.8-mm original shape.

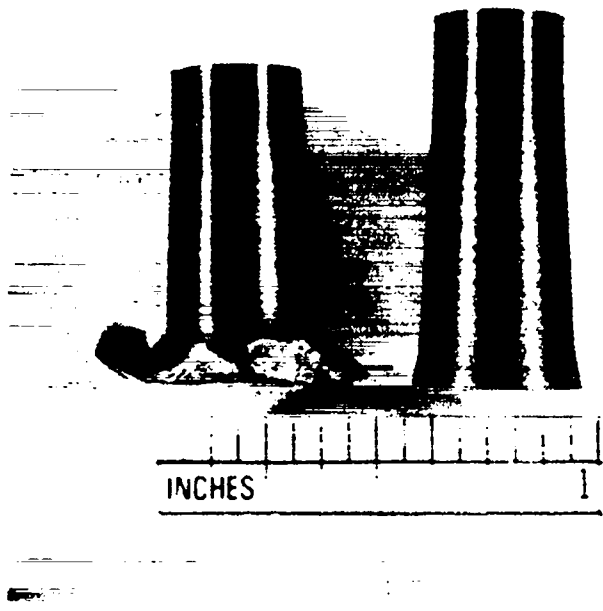

Fig. 3. Photograph of unalloyed fine-grained uranium samples. Tall sample was tested at 150 m/s impact velocity, short sample was tested at 202 m/s impact velocity and partially fractured near the impact face, LA 2233 uranium.

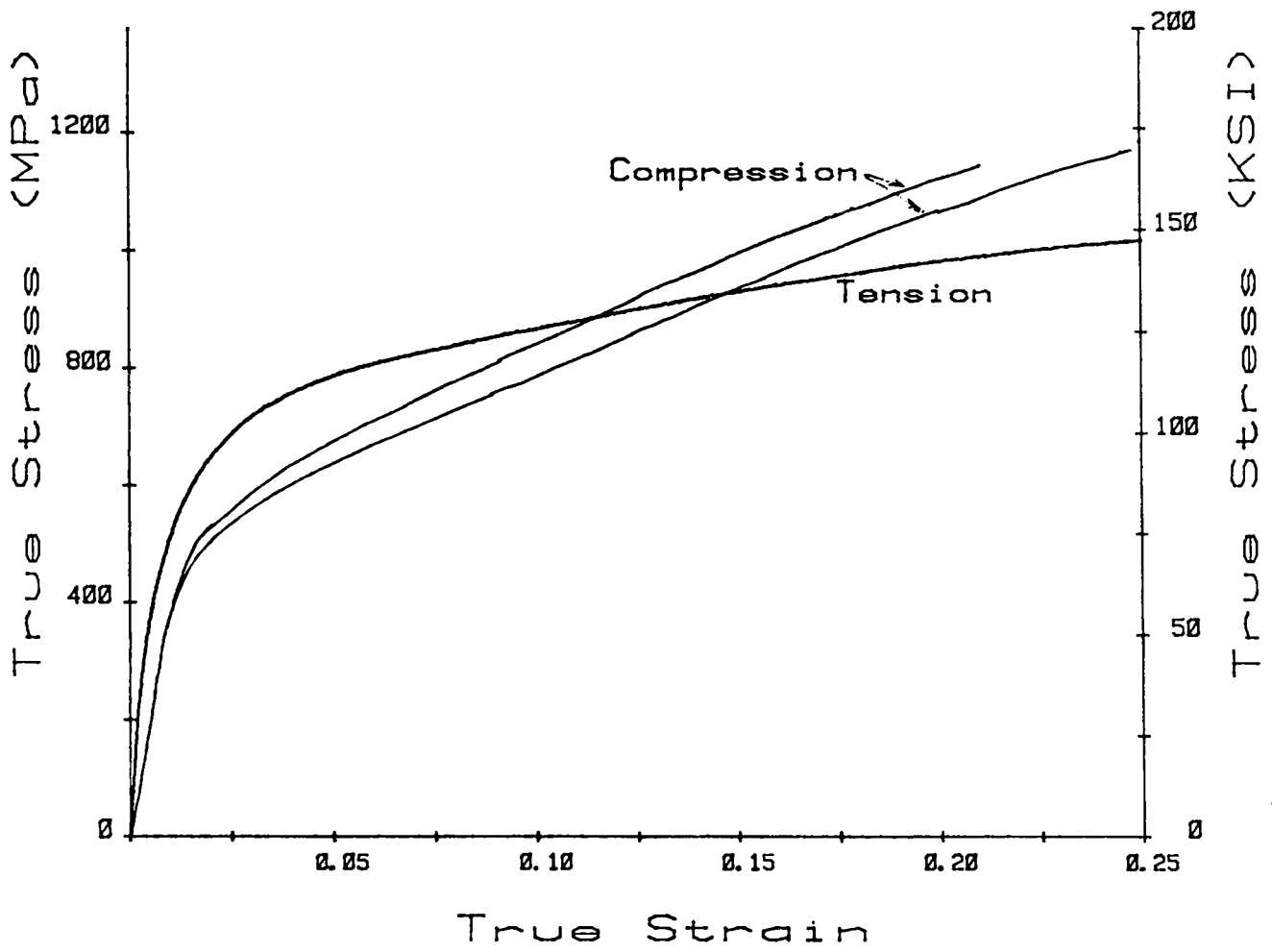

Fig. 4. Comparison of tensile and compressive tests of a fine-grained, randomly-oriented unalloyed uranium. LA 2233

is quite possible that the degree of twinning may differ for the two modes of deformation. Metallographic specimens are being prepared to examine this.

### III. Uranium CM3-8480

Table IIIA contains a summary of the characterization of the three uraniums shot by Mautz. These are discussed in more detail in the following sections.

Uranium CM3-8480 is the material used by Mautz for shot M3-E-4760 and 4761. It was purchased from Y-12 in 1972 as 0.150-in. (3.8-mm) thick by 24-in.-wide by 36-in.-long depleted uranium sheet of deep drawing quality.

The specifications requested that the ingots be cast from derby metal with the total uranium content to exceed 99.9%, carbon content less than 100 ppm with the total of iron, nickel and silicon to be less than 300 ppm. A 65% reduction in area by hot rolling before the final anneal with as many cross-rolling operations as practical was also specified. The sheet was to be given a final anneal at 625°C for 45 to 60 minutes. While no warm rolling was specified, it was not prohibited and the resultant grain size, ASTM 8 to 9, suggest the material was warm rolled extensively. We have been unable to confirm any of the fabrication history at Y-12 (the sheets are 8 years old and records are not kept that long), and are relying completely upon our purchase order specifications for the fabrication history.

Liners were fabricated from this material by deep drawing at 200°C. The deep drawn blanks were stress relieved 1 h at 400°C in a vacuum of  $10^{-5}$  to  $10^{-6}$  Torr before machining to specifications. Material for characterization was taken from the sheet material and also stress relieved 1 h at 400°C in a vacuum of  $10^{-5}$  Torr or better.

Figure 5 shows the microstructure of an actual liner at the pole, 30°, 60° and at the equator of the hemisphere. There is no difference in structure in these areas indicating the material is uniform over the entire hemisphere. This material had a DPH hardness of  $214 \pm 9$ . The uranium sheet material used to make the hemispheres was also sectioned but in such a way as to provide orthogonal views of the material to allow a three dimensional look at the microstructure. Figure 6 shows the microstructures, which are nearly identical, consisting of nearly uniform equiaxed grains; microstructurally the material is isotropic.

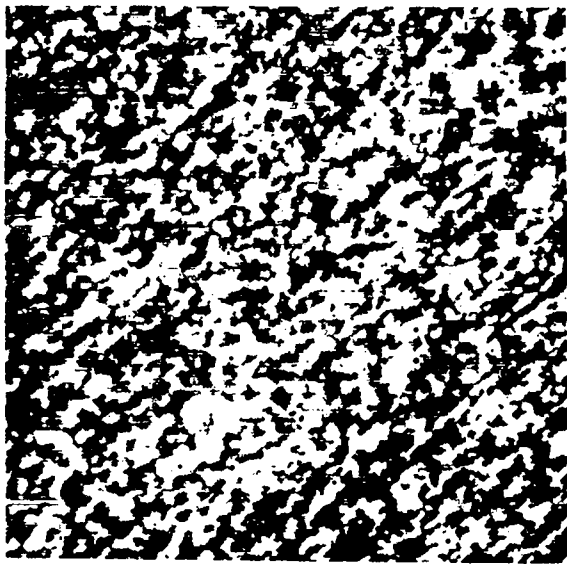

0°

100X

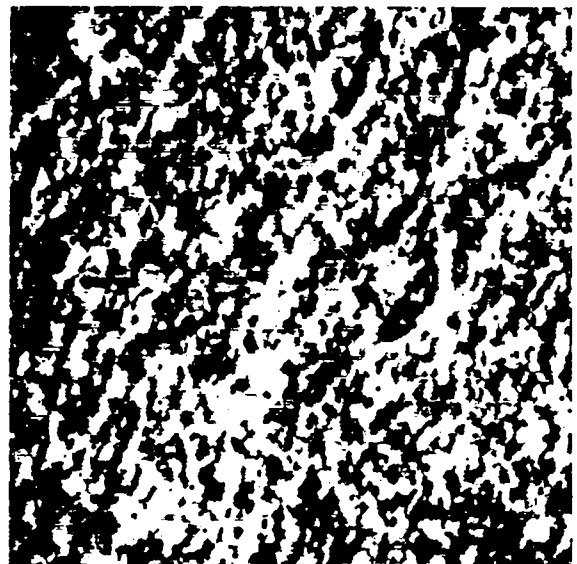

30°

100X

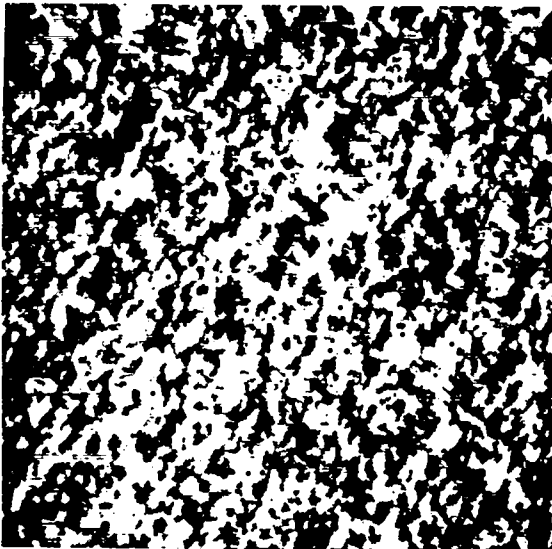

60°

100X

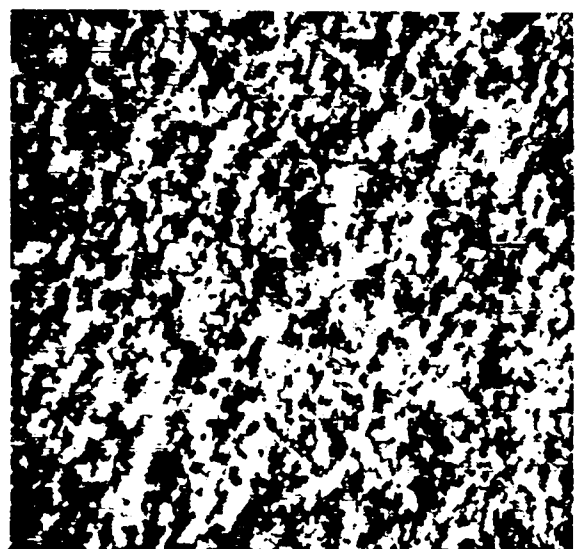

90°

100X

Fig. 5. Structure of liner fabricated from CM3-8480 wrought uranium.

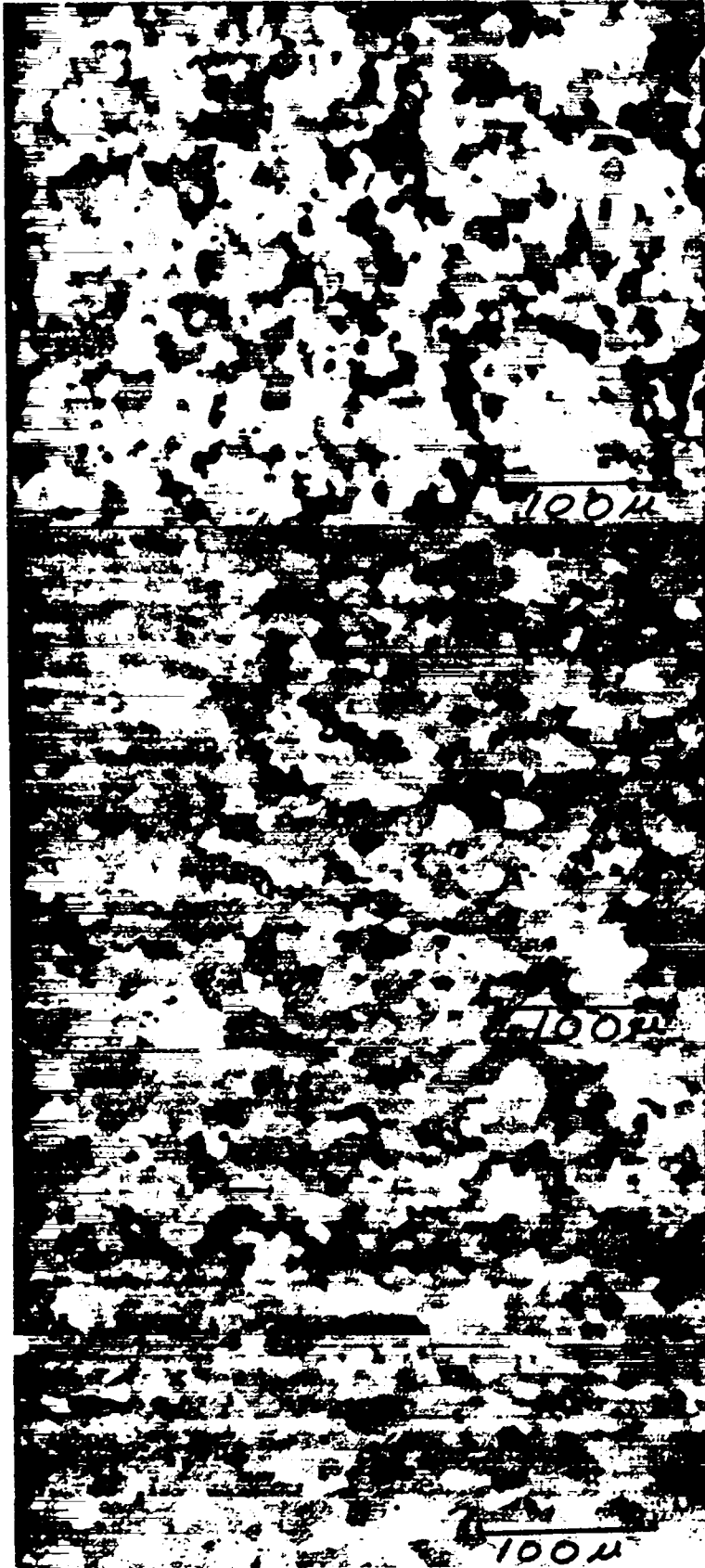

Fig. 6. Orthogonal Views of CM3-8480 Uranium Sheet.

TOP

Metallographic section plane parallel to sheet surface, "B": direction parallel to micrometre scale.

MIDDLE

Section plane perpendicular to sheet surface and to "B" direction. Sheet surface parallel to micrometre scale.

BOTTOM

Section plane perpendicular to sheet surface and parallel to "B" direction. Sheet surface parallel to micrometre scale.

Original magnification 250X, polarized light.



Room temperature tensile properties were determined at several strain rates using miniature specimens cut from the 3.8-mm-thick sheet. The specimens were electropolished before testing to remove any scratches or other stress risers. The low and intermediate strain rate tests were run on an Instron machine, and the high strain rate tests using our 2-in. diam gas gun (TIG).

#### Tensile Tests at Slow Strain Rates

The miniature round tensile specimens, Fig. 6A, had high tensile strength, 845 MPa (123 ksi), a typical yield strength, 228 MPa (33 ksi), a high elongation, 41.3%, and a reduction in area of 42.4% at a strain rate of  $8 \times 10^{-4} \text{ s}^{-1}$ . Results are shown in Table IV.

The uranium had been specified as cross rolled and no primary rolling direction was indicated in the sheets. For testing purposes, we arbitrarily specified two directions, A and B, at right angles to each other. An examination of the data in Table IV for round specimens indicated no statistically significant differences in properties with the specified sheet directions with the exception of ultimate tensile strength where there is a small difference.

The miniature sheet specimens, Fig. 6B, also described in Table IV had very similar properties to the round specimens. Their ultimate tensile strength was 842 MPa (122 ksi), the yield strength 211 MPa (31 ksi), the elongation 40% and the reduction in area 35%. Again, there seems to be a slightly higher ultimate strength in the A direction and in this case a slightly higher yield strength in the B direction; however, only two specimens were tested in each direction and yield strength measurements on uranium are never very accurate.

We conclude that the sheet is only weakly anisotropic in the plane of the sheet insofar as its strength and ductility properties are concerned, and that the sheets were uniform. However, the properties perpendicular to the plane of the sheet are drastically different from the in-plane properties; this will be discussed later.

Two specimens were also tested in the Instron at strain rates of 8.3 and  $8.7 \times 10^{-3} \text{ s}^{-1}$ . The ductility is less than that for the material tested at  $8 \times 10^{-4} \text{ s}^{-1}$  and the strength is a little higher. Numbers for the strength or elongation are not available for these specimens, since the strain rates were varied during the tests in an effort to get a measurement

TABLE III A

CHARACTERIZATION OF THE THREE URANIUMS  
USED IN THE MAUTZ TESTS

<u>CM3-8480</u>	<u>69072</u>	<u>70234</u>
Wrought	Wrought	Cast
Recrystallized	Worked	As Cast
Annealed	Stress Relieved	Furnace Cooled
DPH213	DPH265	DPH242
Fine Grained	Fine Grained	Very Coarse Grained
ASTM 8 to 9	ASTM 7 to 8	ASTM 0
Anisotropic in Plane to Thickness		
40% Elongation		

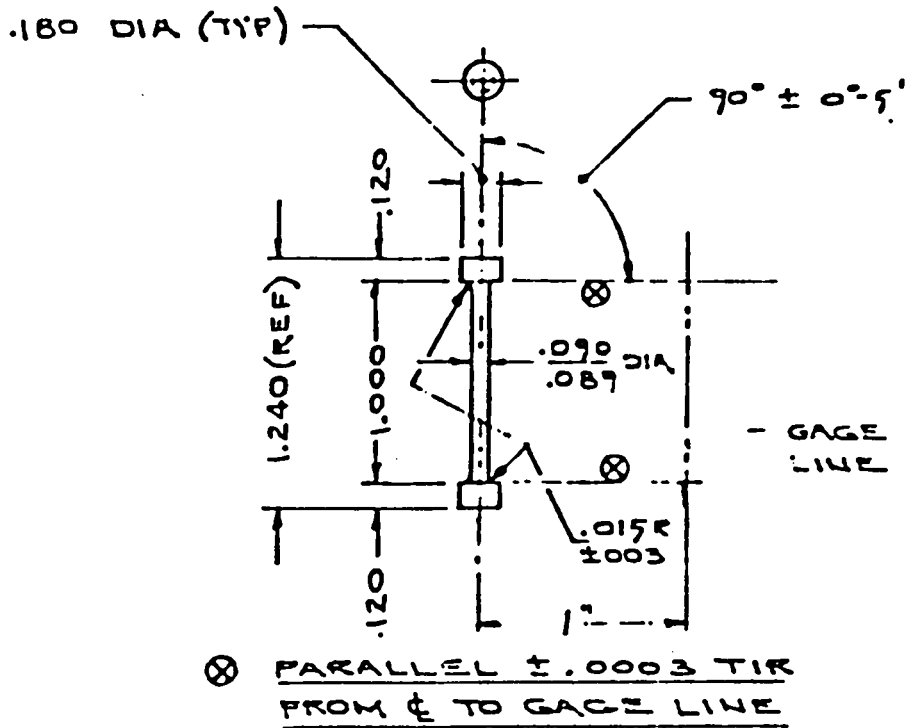

Note: Dimensions in inches

Fig. 6A. Drawing of miniature Round Button Head Tensile Specimen.

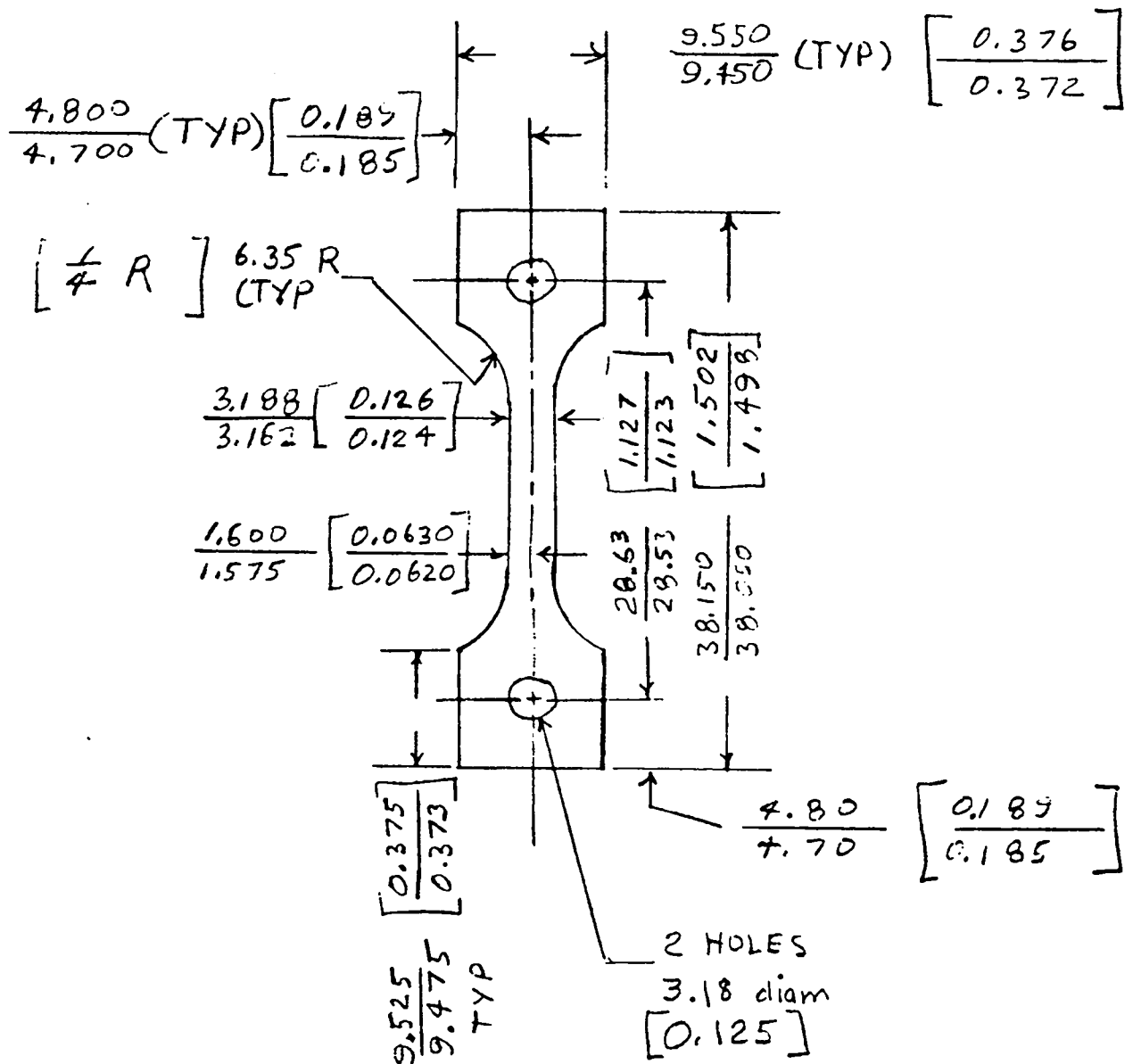

NOTE: dimension in millimetres [inches]

Fig. 6B. Drawing of Miniature Sheet Tensile Specimen.

TABLE IV

ROOM TEMPERATURE TENSILE PROPERTIES OF CM3-8480 URANIUM SHEET  
 STRAIN RATE  $3 \times 10^{-4} \text{ s}^{-1}$   
Button Head Specimens

<u>Specimens Identification</u>	<u>UTS MPa</u>	<u>YS MPa</u>	<u>Total Elong %</u>	<u>RA %</u>	<u>R</u>	<u>Z/X</u>
RF-UL-3	-	-	42.1	-	-	-
RF-UL-4	-	-	40.5	-	-	-
RF-UL-5	-	-	37.1	-	-	-
PA-137-18A	872.3	250.8	43.	42.9	3.8	1.55
PA-137-17A	872.3	250.8	40.5	40.1	5.4	1.79
PA-137-1A	860.6	200.5	44.4	43.8	3.6	1.52
PA-137-16B	819.9	-	42.1	41.1	6.3	1.91
PA-137-15B	819.9	248.0	37.1	45.7	5.8	1.84
PA-137-2B	820.6	190.9	44.9	40.8	6.0	1.87
Mean, all round samples	844.6±26.8	228.1±29.9	41.3±2.8	42.4±2.1	-	-
Mean, A direction	868.4±6.7	234.0±29	42.6±2	42.3±1.9	4±1	1.6±.2
Mean, B direction	820.1±0.4	219.4±40	41.4±4	42.5±2.7	6±1	1.8±.1.
<u>Sheet Specimens</u>						
PA-139-gA	864	203.9	38.9	35.7	-	-
PA-139-hA	861.2	202.6	36.8	35.4	-	-
PA-139-eB	823.4	221.2	40.4	35.9	-	-
PA-139-fB	820.6	217.7	43.8	34.1	-	-
Mean, all sheet samples	842.3±24	211.2±9	40±2.9	35.3±0.8	-	-
Mean, A direction	860.6±2.0	203.3±0.9	37.9±1.5	35.6±0.2	-	-
Mean, B direction	822±2.0	219.4±2.5	42.1±2.4	35±1.3	-	-

of work hardening, but the data were inconclusive. Portions of the stress-strain curves at  $\sim 8.5 \times 10^{-3} \text{ s}^{-1}$  are shown in Fig. 7 along with curves for both faster and slower strain rate experiments.

#### Intermediate Strain Rate Properties

A specimen of CM3-8480 uranium was tested in the Instron machine operated at its fastest usable speed. A strain rate of  $0.39 \text{ s}^{-1}$  was achieved in the specimen. The ultimate strength was 834 MPa, the yield strength 145 MPa and the total elongation 29.8%. Again the specimen had a noticeable elliptical cross section indicating considerable thickness to plane anisotropy. The stress-strain curve for this specimen is also shown in Figure 7.

#### High Strain Rate Properties

Samples of this uranium, CM3-8480, were tested at velocities of 45 m/s, which produced a strain rate of  $1.8 \times 10^3$ . These miniature samples had a pronounced elliptical cross section after testing indicating a strong anisotropy between the plane and thickness of the sheet.

Data from plane-of-the-sheet specimens is shown in Table V. Since there were only two specimens tested in the B direction and one in the A direction, the rather large differences in ductility indicated in the plane of the sheet, should not be taken too seriously. Table VI contains a comparison of the means of the data at the different strain rates used. It is clear that increasing the strain rate at room temperature drastically reduced the ductility of the material.

In our last report covering December 1979 and January 1980, we reported calculations based on the elliptical shape of the necked specimens and their properties that indicated extremely high ultimate tensile strengths in the thickness direction would be expected in this material.

We predicted flow stresses in the through-thickness direction from 50 to 100% greater than in the plane of the sheet. We cannot check these predictions in tension because the sheet is only 3.8-mm thick. We have, however, examined this strength anisotropy in compression.

#### Compressive Strength of CM3-8480 Uranium

Miniature compression samples, 3.3-mm diam and 5.1-mm long, were machined to have their cylinder axes in the plane of the sheet in the "A" direction. Samples 2.3-mm diam and 3.68-mm long were machined with their cylinder axes in the through-thickness directions. They were tested in an Instron machine

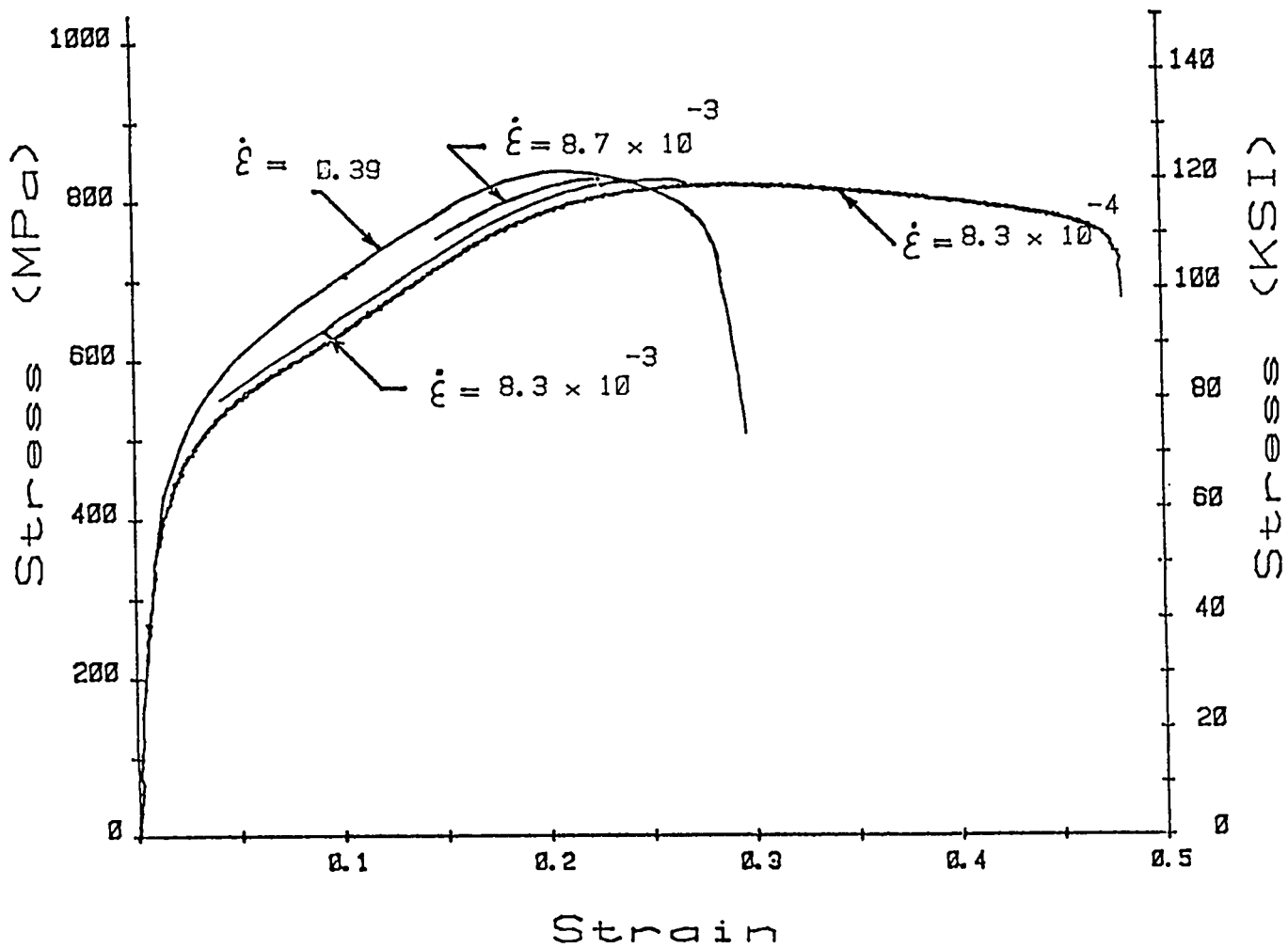

Fig. 7. "B" direction tensile behavior of Y-12 sheet material at strain rates from  $8.3 \times 10^{-4}$  to 0.4/s. uranium CM3-8480.

TABLE V

ROOM TEMPERATURE TENSILE PROPERTIES OF CM3-8480 URANIUM SHEET AT  
HIGH STRAIN RATES,  $1.8 \times 10^3 \text{ s}^{-1}$

<u>Specimen</u>	<u>Final Specimen Preparation</u>	<u>Strain Rate s<sup>-1</sup></u>	<u>Total Elong %</u>	<u>RA %</u>	<u>R</u>	<u>Z/X</u>
RF-UL-1	As machined with gage marks	$1.7 \times 10^3$	26.5	-	-	-
RF-UL-2	As machined	$1.6 \times 10^3$	23.6	-	-	-
PA2-137-20A	Electropolished	$1.8 \times 10^3$	18.1	15.3		-
PA2-137-21B	Electropolished	$1.8 \times 10^3$	25.8	24.9		-
PA2-137-20B	Electropolished	$1.8 \times 10^3$	22.7	22.6		-
Mean all samples	-	-	23.3±3	20.9±5		-
Mean A direction (1 sample)	-	-	18.1	15.3	3.4	1.5
Mean B direction (2 samples)	-	-	24.2±2	23.7±2	6.1	1.9±2

TABLE VI

ROOM TEMPERATURE MEAN PROPERTIES OF CM3-8480 WROUGHT AND URANIUM SHEET  
AT SEVERAL STRAIN RATES

<u>Strain Rate s<sup>-1</sup></u>	<u>UTS MPa</u>	<u>YS MPa</u>	<u>Total Elongation %</u>	<u>Red Area %</u>
$8 \times 10^{-4}$	845	228	41.3	42.4
0.39	834	145	29.2	-
$1.8 \times 10^3$	-	-	23.3	20.9

in a special subpress at a displacement rate of 0.008 mm/s giving a strain rate of about  $2 \times 10^{-3} \text{ s}^{-1}$ . Typical stress-strain curves are shown in Fig. 8 and are compared to tensile results. The comparisons are all made on the basis of true stress and true (logarithmic) strain. The compressive flow stress curve in the plane of the sheet exhibits an inflection, starting out lower than the tensile curve and finishing higher. This behavior is similar to that observed for the randomly oriented uranium shown in Fig. 1. Work hardening is considerably more rapid for the through-thickness compression sample resulting in much higher strength levels. The strength increase in the through-thickness direction varies from  $\sim 80\%$  during early flow to 23% at 25% strain. It is quite remarkable for unalloyed uranium to reach flow stress levels of 1450 MPa (210,000 psi).

Compression samples from the plane of the sheet deformed to an elliptical cross section similar to what was observed in tension. This, of course, reflects the through-thickness anisotropy. Samples before and after deformation are shown in Fig. 9. Compression samples from the thickness direction retained a circular cross section during testing. This indicates that this material has little "planar" anisotropy, most likely a consequence of the cross rolling process during fabrication.

Comparison of the through-thickness direction compression data to the compression and tension data from the fine-grained, randomly-oriented material is shown in Fig. 10. The sheet material, CM3-8480, is considerably stronger, particularly in the early part of deformation.

A comparison of the properties of CM3-8480 uranium as a function of strain rate is shown in Table VI. The ductility clearly decreases with increasing strain rate. Figure 7 contains a series of stress-strain plots at low and intermediate strain rates. It shows a major decrease in strain to failure with increasing strain rate even at slow to moderate strain rates.

#### X-Ray Orientation Measurements

Two samples of uranium CM3-8480 were examined and neither gave the sharp, well defined pole figures which are characteristic of more highly rolled U sheet; however, some weak anisotropy was nevertheless apparent. In both, the textures could best be described as moderate (100) [010] and (114) [140] plus minor (100) [001]. The (100) [010] and (100) [001] textures are



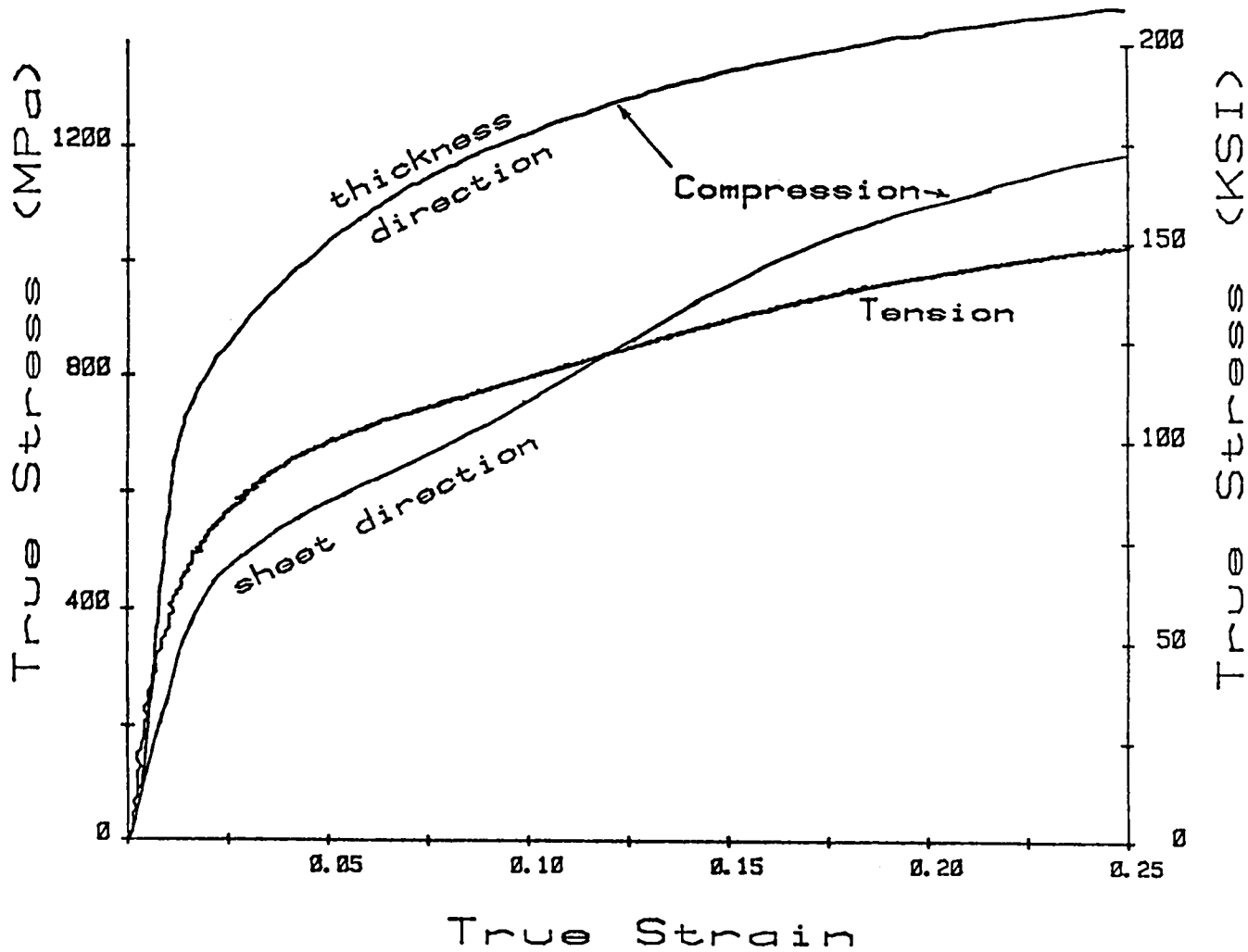

Fig. 8. Comparison of tensile and compressive tests of an unalloyed uranium, CM3-8480, sheet material (Sheet direction "A").

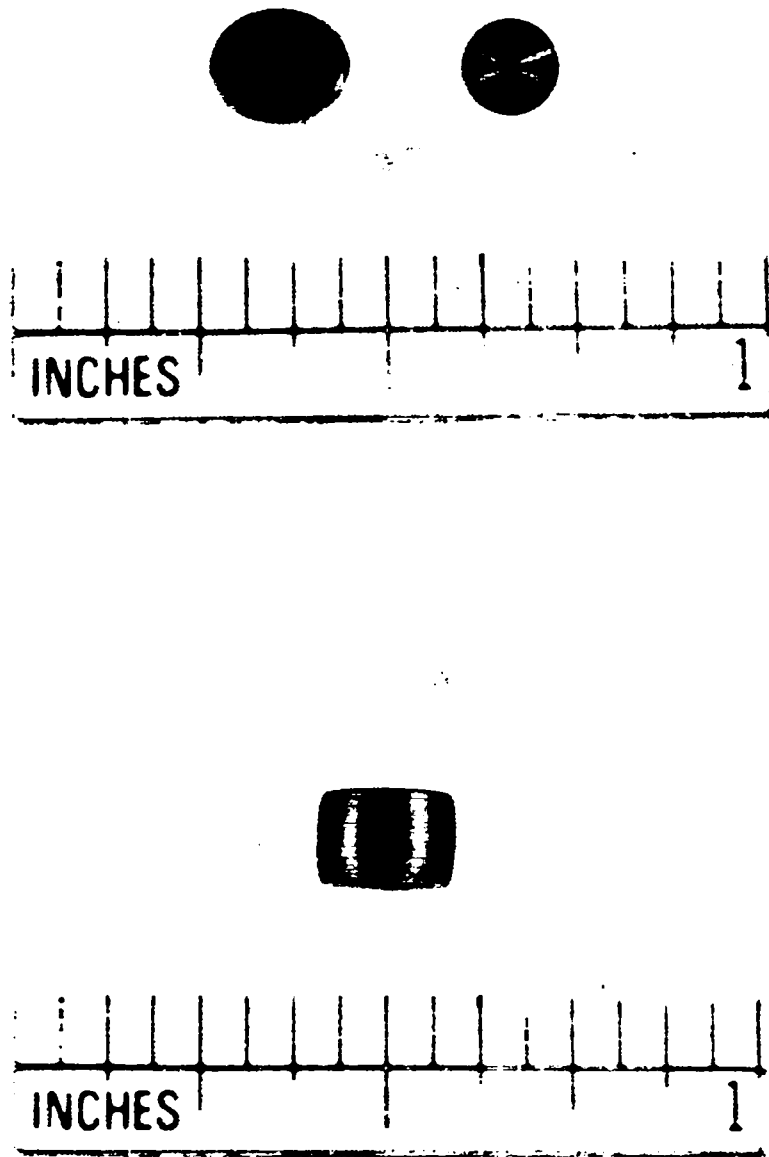

Fig. 9. Miniature "A" direction compression specimen strained 25%. Top photograph: Right, end view of specimen before test; Left, specimen after test. Lower photograph: side view after test. CM3-8480

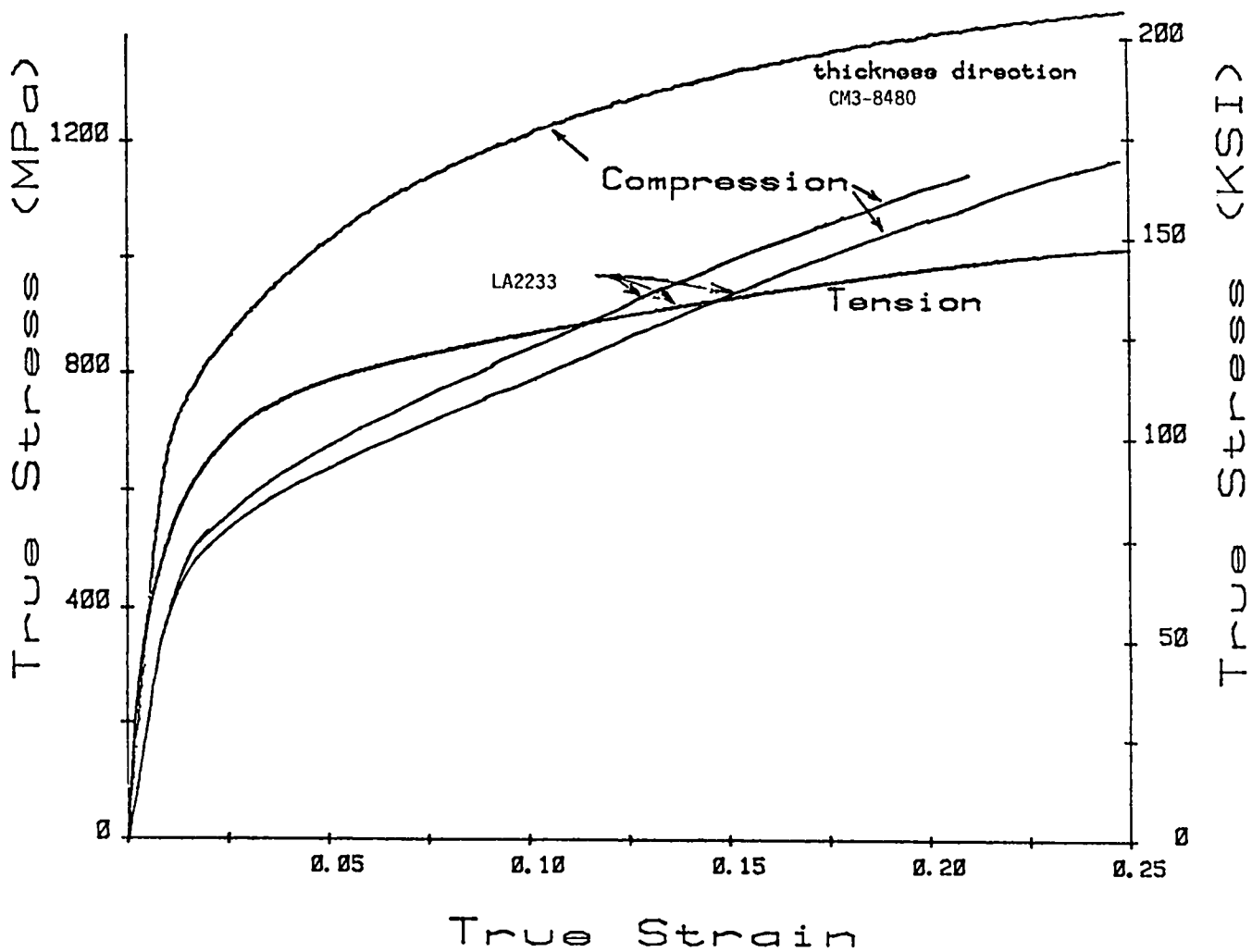

Fig. 10. Comparison of through-thickness CM3-8480 uranium sheet compressive tests to randomly-oriented uranium LA 2233.

complimentary and probably resulted from cross-rolling. The (114) [140] orientation may have been introduced during an intermediate anneal. A marked feature of both pole figures was the degree of aximuthal asymmetry, a feature much more pronounced in one of the samples than in the other. This asymmetry could lead to minor variations in certain mechanical properties when measured in different directions within the sheet surfaces.

### Taylor Anvil Tests

We machined miniature Taylor anvil samples from the CM3-8480 uranium sheet. The maximum diameter was limited by the sheet thickness of 3.8 mm. Three specimens were machined such that the cylinder axis was in the plane of the sheet, running in what we have called the "A" direction. These specimens were 3.30-mm diam by 10.15-mm long. They were tested at  $159 \pm 8$  m/s,  $180 \pm 4$  m/s and  $196 \pm 2.8$  m/s. The specimen tested at 159 m/s deformed without fracture as shown in Fig. 11c. Maximum radial strains at the impact face reached 41%. The axial and radial strain distributions are shown in Figs. 12 and 13. The deformed cross section was elliptical as in the tensile specimens, reflecting a strong through-thickness anisotropy. Only the maximum strain direction is shown in Fig. 13. The specimen tested at 180 m/s exhibited several small cracks at the impact face. The maximum radial strain at the impact face was 79%. The specimen tested at 196 m/s fractured catastrophically at the impact end. It is not shown here. One specimen was machined from the "B" direction in the plane of the sheet (perpendicular to direction "A"). It was impacted at  $171.3 \pm 0.4$  m/s and survived with only a few small cracks (see Fig. 11b). The maximum diametral strain was 63%. We have not yet attempted the numerical analysis of the Taylor anvil results. However, it is apparent that we will need the capability to handle anisotropic materials in order to obtain satisfactory predictions.

### Biaxial Testing

Eight disks, 0.76-mm thick and 60.32-mm diam, were fabricated from the same sheet of CM3-8480 uranium used to fabricate button-head and sheet tensile samples. Four of these disks were stretched biaxially in a fixture that supports the disk near the outer circumference and hydraulically bulges the center region. The hydraulic force was generated by pushing a round-nosed

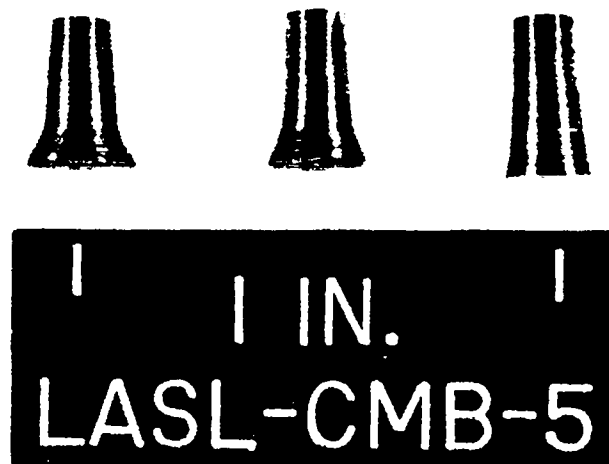

Fig. 11. Miniature Taylor anvil specimens. Original dimensions 10.16-mm long, 7.62-mm diameter. Left: "A" direction material tested at  $180 \pm 4$  m/s; Center: "B" direction material tested at  $171.3 \pm 0.4$  m/s; and Right: "A" direction material tested at  $159 \pm 8$  m/s.

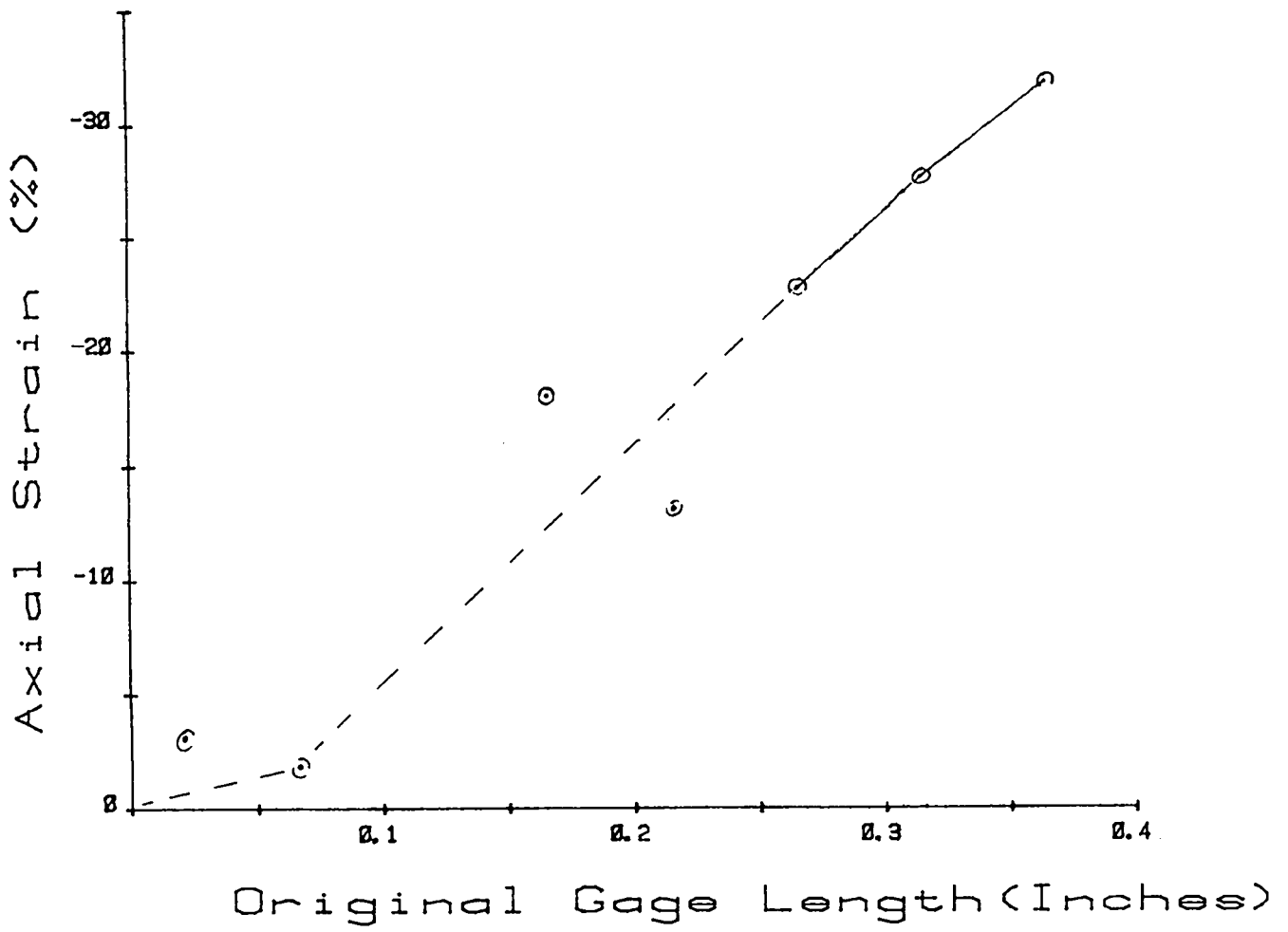

Fig. 12. Axial strain of "A" direction material Taylor anvil specimen of uranium CM3-8480 tested at a velocity of 159 m/s.

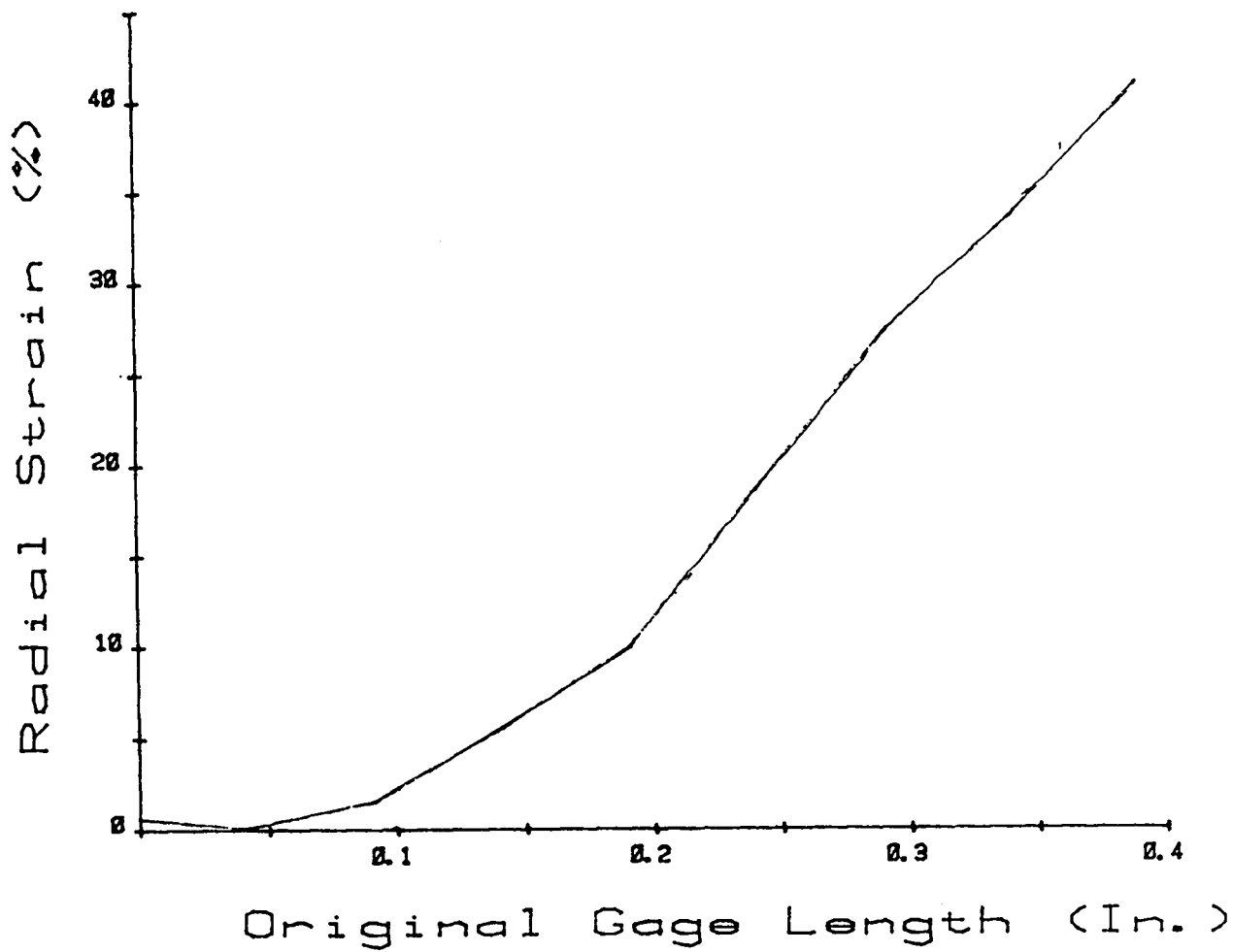

Fig. 13. Radial strain profile of "A" direction of uranium CM3-8480 Taylor anvil specimen tested at a velocity of 159 m/s.

punch against a confined polyurethane rubber disk which in turn pressed against the sample. A sketch of the assembly is shown in Fig. 14. This same arrangement is used for high speed testing, by accelerating the punch in an air gun apparatus instead of a low speed testing machine.

Four tests were run but were unsuccessful because the samples fractured near the hold-down groove in the supporting fixture rather than near the center where the hydraulic forces create a maximum biaxial stress condition. Only about a 9% biaxial strain was produced (in the central region) before the failures occurred at the periphery. These results indicate that this material has very low ductility under plane strain loading (one of the principal surface strains equal to zero) which is experienced in the hold-down groove. We attempted to form this groove at elevated temperature to alleviate this problem.

Several disks were heated to 200°C before forming the necessary hold-down grooves, then tested at low speed at room temperatures. The groove-forming was successful, but the samples still failed by cracking at the die interface. A new die has been designed, fabricated and successfully tested with aluminum specimens. It will be heat treated before attempting a uranium test.

Cracking of the biaxial disks at the die periphery indicates a low ductility under conditions of plane strain ( $\epsilon_x > 0$ ,  $\epsilon_y = 0$ ). We are attempting to measure the plane-strain ductility with a modified sheet tensile test. The details of this test are being worked out with a low-carbon steel.

#### IV. Run-of-the-Mill Uranium, 69072

The second uranium being examined, Table I, is a so called run-of-the-mill material, uranium 69072. It was selected as typical of a present production grade uranium that is readily obtainable. The material was cast and hot rolled at Y-12 to 25.4-mm-thick plate. Its chemical analysis is shown in Table II.

This plate was hot rolled in the alpha phase from a salt bath to 6.35-mm-thick plate and then warm rolled from an oil bath to 3.8-mm-thick sheet at LASL. Blanks were machined and liners deep drawn from this material at 200°C. These liner blanks and portions of the warm rolled sheet (used for material property measurements) were vacuum annealed at 400°C for 1h to



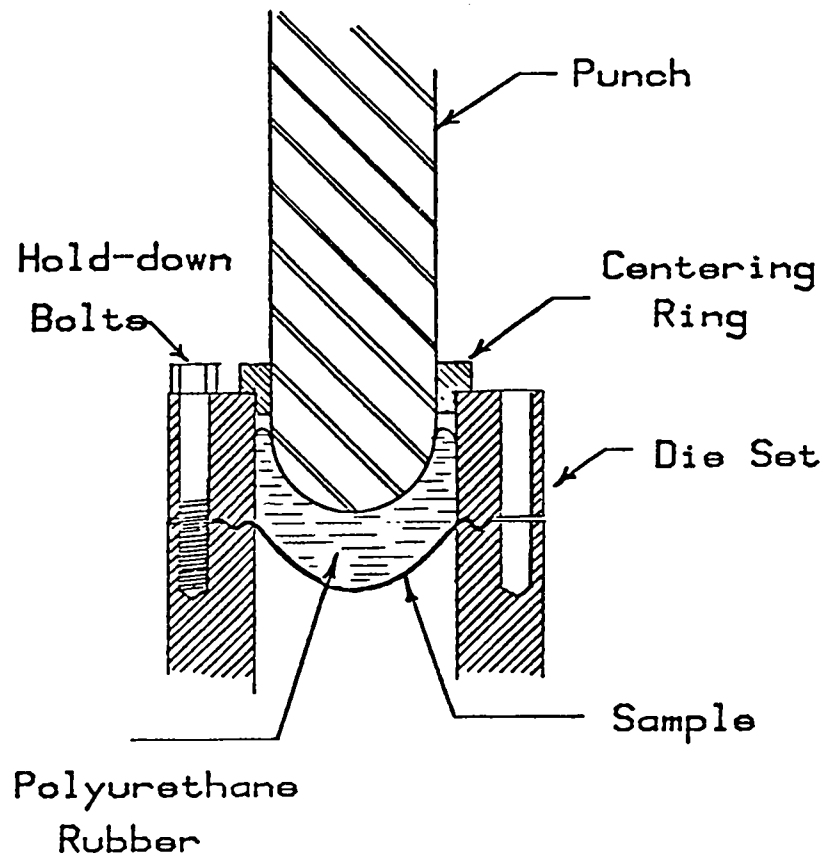

Fig. 14.

Biaxial sheet test.

stress relieve the material and remove most of the hydrogen. As shown in Fig. 15, the structure of these materials in as worked or stress relieved conditions are identical. This material was not recrystallized. The DPH hardness of the as worked material was 295 and that of the stress relieved 265. Since fully annealed material has a hardness of about 200, it is obvious that this material still contains considerable residual stress.

Uranium 69072 is a very different wrought material than the CM3-8480 material. It was given a simple processing treatment that should be easy to duplicate in production at a minimum cost. (It would be informative to recrystallize some of this material to form a fine grained equiaxed structure with a hardness of about DPH 200 and test it as a liner.)

Specimens are being machined from the stress relieved sheet used to make the liners and we expect high strain rate testing of this material to get underway soon.

#### V. Cast Uranium 70227, 70233, and 70234

The third uranium tested by Mautz in his series was a LASL fabricated cast material numbered 70227, 70233 and 70234 which will be used for identification of the materials. These materials were cast in the form of hemispheres with 9-mm-thick wall using standard uranium casting methods at LASL. The bottom pour crucible, the stopper rod, and the mold were machined from graphite and coated by flame spraying with yttria. The walls of the hemisphere were cast 9-mm thick to ensure forming a sound casting large enough to machine into liners.

This casting procedure adds some carbon to the uranium. Chemical analyses of the castings, 70277 and 70233 are given in Table II. The two castings analyzed were used for the liners that were tested. There is excellent agreement on the chemistry between the castings as should be expected. Carbon results are pending.

Samples are being taken from a third casting made at the same time, 70234, in the identical manner and these will be used to determine the high strain rate properties and to further characterize this uranium. It will be necessary to cast a plate, 9-mm thick, of uranium under the same conditions used for the hemispheres to obtain enough material to completely characterize the cast uranium material.

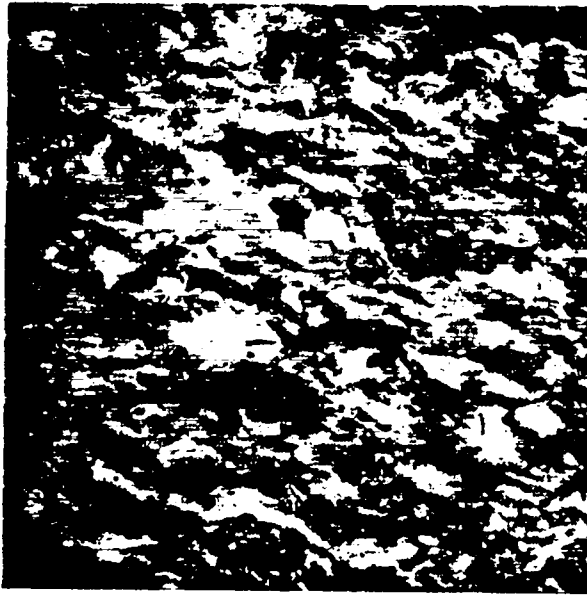

As warm rolled 100X

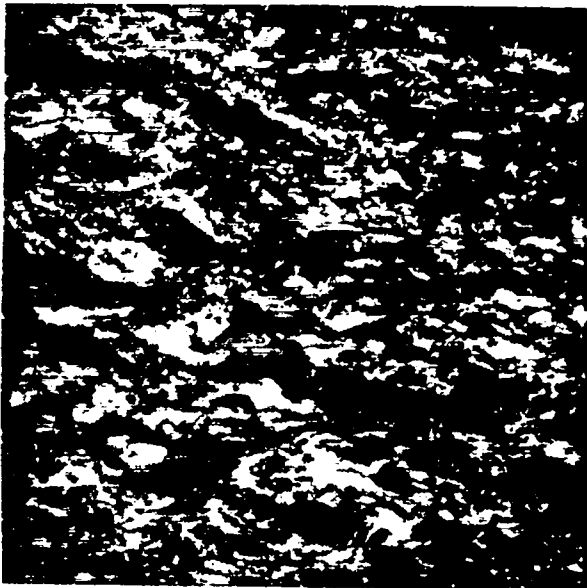

Warm rolled 60% and stress  
relieved 400°C for 1 h 100X

Fig. 15. Structure of Run-of-the Mill Uranium #69072.

Casting 70234 was sectioned and metallographic samples taken at the pole, 30°, 60° and the equator to determine the structure and uniformity of the castings. As shown in Fig. 16, the casting is uniform and has the large grains typical of cast material. The grain size is ASTM 0 and the hardness DPH 242.

#### LASL Uranium Sheet C1-900 and C1-901

High quality derby uranium feed stock obtained from Y-12 with a low 60-85 ppm carbon content was used for CMB-6 casting number C1-900. The material fabricated from this casting is identified as LASL-C1-900 uranium. There is enough material available in sheet form to completely characterize its properties as a function of strain rate and to fabricate the liners necessary to obtain performance data if desired.

This uranium has been processed and the sheet is being edge machined to remove any damage incurred during the warm rolling process. A complete fabrication history of uranium LASL C1-900 is given in Table VII.

A grade of very low carbon uranium derby material was obtained from Y-12 and cast into an extrusion ingot, LASL-C1-901. The Y-12 analysis indicated ~ 20 ppm of carbon present. Originally we planned to cast the very low carbon materials in an all ceramic system. Problems with excessively slow mold cooling rates resulting in huge grains and poor extrusion behavior caused us to abandon this procedure for the time being. We are still working on all ceramic casting system under other programs.

This uranium, number LASL-C1-901, was cast from a MgO crucible using a MgO stopper or pouring rod and a yttria coated graphite mold. Details of the fabrications procedure to date are given in Table VIII.

These materials are scheduled for further characterization and high strain rate testing soon.

#### VI. Hopkinson Split Pressure Bar Status

The Hopkinson split pressure bar purchased by LASL has been delivered and is currently being set up for operation. Factory representatives are expected soon to perform the performance check out.

We are planning to run Hopkinson bar tests on several of the uraniums being examined at room temperature. Work will also get underway soon on a high temperature capability for the Hopkinson bar.



0°

100X

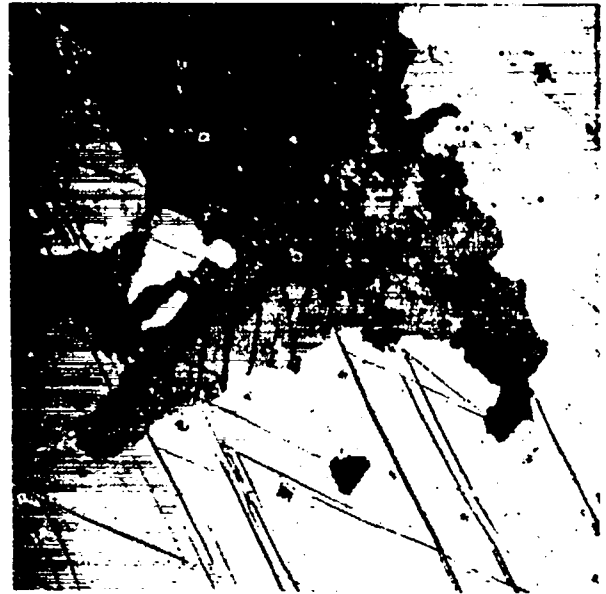

30°

100X



60°

100X

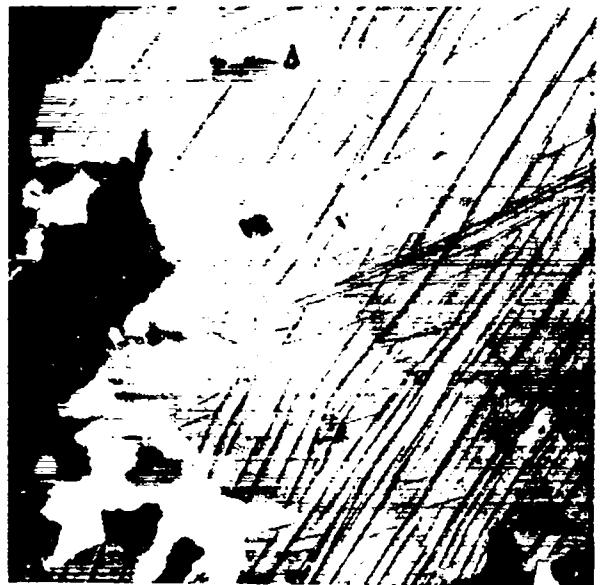

90°

100X

Fig. 16. Structure of liner made from LASL cast uranium.

TABLE VII  
FABRICATION HISTORY OF LASL-C1-900 URANIUM

1. Casting #C1-900  
 Feed Stock - derby uranium 50 to 80 ppm carbon (not the final carbon content). Y-12 source  
 Crucible - graphite, flame sprayed with yttria  
 Mold - graphite, No. 3683, 114-mm diam by 250-mm long, flame sprayed with yttria  
 Pour temperature - 1335°C  
 Mold temperature - 757°C top and 645°C bottom
2. Machined to ~ 100-mm-diam by 100-mm-long extrusion billets
3. Grit blasted and silver plated.
4. Extruded using high energy rate (HER) on Dynapak to 50-mm-diam rod  
 Energy - 57,000 joules (42,000 ft. lbs)  
 Temperature - 850°C  
 Reduction in area ~ 4
5. Machined to ~ 45-mm-diam by 50-mm-long forging blanks
6. Grit blasted and silver plated
7. Forged using HER to ~ 20-mm-thick plate  
 Velocity - ~ 7.62 m s<sup>-1</sup>  
 Temperature - 450°C  
 Reduction in thickness - ~ 60%  
 Energy - 35,000 joules (26,000 ft. lbs)
8. Machined circumference to remove stress risers.
9. Cross Rolled from oil to 3.8-mm-thick sheet  
 Temperature - 325°C  
 Reduction in thickness - 80%  
 Four high Loewy mill used.
10. Annealed (recrystallized) at 625°C for 1 h.
11. Machined circumference to remove any edge damage
- \*12. Drawn to hemishe11s
13. Stress relieved at 400°C for 1 h  
 Vacuum - < 10<sup>-5</sup> Torr  
 Furnace number 156807 used

\*Step 12 skipped for material used for mechanical properties testing.

TABLE VIII  
FABRICATION HISTORY OF LASL-C1-901 URANIUM

1. Casting #C1-901  
Feed Stock - Very low carbon, 20 ppm, uranium Y-12  
Crucible - MgO  
Mold - Graphite, 120-mm-diam, flame sprayed with yttria  
Pour temperature - 1350°C  
Mold temperature - 752°C top, 645°C bottom
2. Machined to ~ 100-mm-diam by 100-mm-long billets
3. Grit blasted and silver plated
4. Extruded - In process at present
5. Fabrication in process will be continued using a very similar procedure to that used for casting C1-901.  
The history will be reported when completed.

#### VII. Conclusions

Testing of the material used for Mautz's "first" shot, uranium CM3-8480, is well along and it certainly appears to be what we would call "good" uranium. It has a high tensile strength, typical yield strength, and excellent ductility when tested at room temperature using slow strain rates. As the strain rate increases, the ductilities decrease. The material is reasonably isotropic in the plane of the sheet but exhibits marked anisotropic behavior between the plane and thickness of the sheet with the thickness direction showing very high strengths.

Several other uraniums are in various stages of examination and preparation, and the program is now running very smoothly. The results of Mautz's three uranium shots and our partially completed characterization of these materials certainly justifies the belief that the material properties and history are important factors in determining liner performance.